

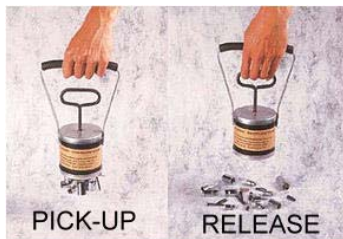

KA-2708 Magnetic Holder

- Attaching to any metallic surface
- Capacity: 6 Lbs
- Size: Disk diameter: 50mm
- Magnetic Power: 1200 gauss
- Weight: 75g



KA-2709 Quick-Release Magnetic Pick Up Tool

- A one-hand operation for pick-up and releasing nails, steel screws, nutetc any small parts.
- 9" Wide x 3-1/2" Diameter.
- Capacity: 5 Lbs.
- Ideal for cleaning-up around power equipment such as drill presses, milling machines and lathes.



KT-N0001 Heavy Duty Creepers

- Features 1" steel tube frame for extra strength in heavy duty applications.
- Unique drop rail design allows greater shoulder and arm clearance.
- 1" thick padding on bed; 2" thick padding on headrest.
- Adjustable pneumatic headrest for maximum head comfort and shoulder support.
- Size: 1020 x 430 x180mm



KT-N0002 Plastic Creepers with 6 Wheels

- 40" ergonomically designed frame
- 6-3" swivel casters make it extremely maneuverable
- Vinyl covered foam head rest for maximum comfort
- Two small storage trays conveniently located on either side
- A low profile of 1" allows for greater clearance under vehicles



KA-J9002



KA-6335

KA-J9002 Magnetic Three-in-One Can Opener

- Can opener: S2
- Chamfer tool: S2
- Sharpener: Grindstone
- Handle: ABS cover TPR
- Magnet: Permanent magnet

KA-6335 Magnetic Cap Opener

- L type can opener, easy for opening the paint can or milk can, also helpful for clearing the thorns in tires.
- With a small magnet in the handle that make the storage more convenient.
- Description: L:85mm , W:15mm



KA-7841



KA-7841A * suits to high chassis vehicle

Tyre Transport Dolly

- Dolly for transporting stacked car tyres and wheels.
- Designed for easy, one-person movement.
- Space saving for workshop.
- Labor saving and increases work efficiency.
- Dollies are stackable when not in use for easy storage.
- Heavy-Duty 3" casters including two brake casters make for smooth mobility and stability.



	KA-7841	KA-7841A
Dimension	64 x 64 x 17.5cm	64 x 64 x 54.5cm
Weight	5.5kgs	8.5kgs
Loading Capacity	150kgs	150kg
Caster 3"	Swivel caster x 2pcs Brake caster x 2pcs	Swivel caster x 2pcs Brake caster x 2pcs

KA-1273 Saving Storage Container

Features:

- Patent design
- Stackable in use nest for compact storage
- Available in white PP or semi-clear PP for greater visibility
- Easy cleaning

Specification:

- Temperature range: -20°C ~ 100°C
- Dimension: 388 x 327 x 85mm
- Material: PP (Reinforced plastic material)



KA-1274



KA-1274W With wheel

Utility Carry Box

KA-1274 KA-1274W

Features:

- With ruler mark in both metric & inch units
- Caster design(optional) provides great maneuverability
- Stackable and ergonomic design provides best flexibility

Specification:

- Dimension: 340 x 567 x 240mm
- Weight: 1366g / pc
- Material: PP (Reinforced plastic material)



Drum Plug Opener

- For removing and refitting fuel tank sender mounting rings
- The high quality tool makes jobs faster more precise

Model	Material	Dimension	Weight
KA-7253	Aluminum	315x115x40mm	525g
KA-7254	Aluminum	380x105x50mm	420g
KA-7255	Plastic	220x70x50mm	107g

KA-7253



KA-7254



KA-7255



KA-2444 Elastic Tow Rope

- Description: 7/8" 1.5M
- Breaking Cap: 2100kgs (4620lbs)



KA-1012 27pcs Knife & Scraper Set

Content:

- 1pc Knife with 0.6mm blade
- 1pc Scraper with 12mm blade
- 5pcs 12mm blade
- 5pcs 16mm blade
- 5pcs 16mm/53° blade
- 5pcs 20mm blade
- 5pcs 0.6mm blade



KA-1342 9" Tower Pincers



KA-1293 Snow Grabber Mat (2pcs/set)

- To escape from skid on snow or mud.
- Avoid shoveling and stress on your car's transmission, avoid tow costs and tiresome pushing.
- Simply put the mat under your car's drive wheel and go.
- Big size: a set of 2 sheets, per sheet of 60 x 23.5cm.
- Made of heavy duty polymer & cold resistance: -30°C
- For normal passenger cars use only.
- Grabber mat are both face claws.

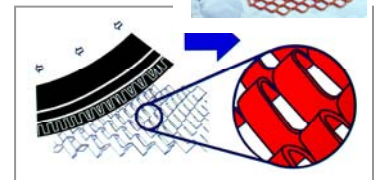

Engine Stands

- Heavy-gauge steel tubing for strength and rigidity.
- Easy to disassemble for transporting or storage.
- Head with adjustable mounting arms attaches to engine block.
- Swivel head 360 ° X for easy accessibility.
- Slotted adjustable saddle permits quick and easy installation.
- Heavy-duty swivel 4 caster steel wheel for added stability.



KJ-M50750
Capacity: 750 LBS



KJ-M51000
Capacity: 1000 LBS



KJ-M51250
Capacity: 1250 LBS



KJ-M52000
Capacity: 2000 LBS



KJ-M52001 Heavy-Duty
Capacity: 2000 LBS



KJ-M52002 Folding Type
Capacity: 2000 LBS

Engine Crane (Hoist)

- Perfect for a variety of heavy duty applications.
- Heavy steel construction for maximum durability
- Features an 8ton detachable long ram
- Telescoping boom permits multiple length adjustment
- Smooth hydraulic lift operation
- Includes heavy steel hook with safety latch
- Large roller bearing wheels provide easy maneuvering
- Wide base for stability
- Easily disassembles for storage or transport
- Folds for easy storage or transport. Knock-down design reassembles in minutes



KJ-M71000

- Capacity: 1 Ton
- Min. ~ Max. Height: 0 ~ 2280mm



KJ-M71001

- Capacity: 1 Ton
- Min. ~ Max. Height: 200 ~ 1940mm



KJ-M72000

- Capacity: 2 Ton 2000 LBS
- Min. ~ Max. Height: 0 ~ 2520mm



KJ-M72001

- Capacity: 2 Ton
- Min. ~ Max. Height: 0 ~ 2360mm



KJ-M72002

- Capacity: 2 Ton
- Min. ~ Max. Height: 0 ~ 2340mm



KJ-M73000

- Capacity: 3 Ton
- Min. ~ Max. Height: 0 ~ 2200mm

Transmission Jack

- Foot operated for raising and lowering, release valve to give controlled lowering.
- Chrome plated rams and pump piston for prolonged seal life.
- Strong tubular construction and wide base provide greater stability.
- Fully adjustable saddle tits four ways.
- Two-stage telescoping design provides extra lifting range.
- Oil bypass system prevents the lifting ram from being over-pulled.
- Ball bearing casters with large 4i" diameter wheels allow smooth positioning and transporting.

Item No.	Capacity	Stroke Height (mm)
KJ-M8050A	0.5 Ton	820
KJ-M8050B	0.5 Ton	1ST Stage: 500 2ND Stage: 490
KJ-M8050CE	0.5 Ton	1ST Stage: 500 2ND Stage: 450
KJ-M8050D	0.5 Ton	1ST Stage: 490 2ND Stage: 460

Item No.	Capacity	Stroke Height (mm)
KJ-M8050E	0.5 Ton	500
KJ-M8050F	0.5 Ton	1ST Stage: 510 2ND Stage: 480
KJ-MTJ1000A	1 Ton	210~ 810
KJ-MTJ1000B	1 Ton	230~ 760



KJ-M8050A



KJ-M8050B



KJ-M8050CE



KJ-M8050D



KJ-M8050E



KJ-M8050F



KJ-MTJ1000A



KJ-MTJ1000B

Body and Frame Repair Kit



10 Tons Portable Power Master Set

KA-6069 Sing speed pump

KA-6070 Two speed pump

Parts No.	Q'ty	Description
210-01	1	Hydraulic pump
210-02	1	Hose and couple
210-03	1	10 ton ram 6" (152mm) stroke
210-04	1	Spreader ram
210-05	1	19" (482mm) extension tube
210-06	1	14" (335mm) extension tube
210-07	1	10" (254mm) extension tube
210-08	1	5" (127mm) extension tube
210-09	1	Male connector
210-10	1	Flat base
210-11	1	90° "V" base
210-12	1	Wedge head
210-13	1	Spreader plunger toe
210-14	1	Spreader ram toe
210-15	1	3-1/4" (83mm) flex haed
210-17	1	Serrated saddle
210-18	1	Metal box



KA-6071 12 Ton 1/2" - 2" Hydraulic Pipe Bender

12 Ton hyd jack

- FORMERS: #1 1/2"
 #2 3/4"
 #3 1"
 #4 1-1/4"
 #5 1-1/2"
 #6 2"



KA-6193 Air Pump

- This air-power hydraulic pump is designed for using with single-acting cylinders and tools.
- Rugged construction and most components are made of aluminum alloy are built for long service life, easy operation and portability.
- Automatic overload relief setting as 10000 psi protects components in hydraulic system and work safely regardless of air pressure.
- New inlet & outlet design feature low exhausting air volume, non-noise effect and being operated in all directions.



KA-5558-G 7-IN-1 Multi-Function Tool Kit

- Scraper 16mm×185mm×75mm (CRV6150)
- 1 - Slide Hammer Hook
- 2 - Chisel 16mm×185mm×27mm(CRV6150)
- 3 -Rear Axle Bearing Puller
- Size: 1", 1 ⁷/₈" , 1 ⁵/₁₆" , 2 ³/₈" , 1 ³/₈" , 2 ⁷/₈" (SCM 4140)



KA-5558-H 7-IN-1 Multi-Function Tool Kit

- 2 - Chisel 16mm×185mm×27mm(CRV6150)
- 4 - Bearing Hole Puller (SCM440)
- Size: 10-14 mm 15-19 mm 18-25 mm 25-32 mm
- 1 - Scraper 16mm×185mm x75mm(CRV6150)



KA-5558-J 3-IN-1 Multi-Function Tool Kit

- 1PC- ¹¹/₁₆" TIE ROD
- 1PC- ¹⁵/₁₆" BALL JOINT
- 1PC-1 ¹/₈" PITMAN ARM

Material : SCM45°



KA-5558-K 6-IN-1 Multi-Function Tool Kit

- 1-Scraper 16mm×185mm75mm(CRV6150)
- 2-Chisel 16mm×185mm×27mm(CRV6150)
- 1PC- ¹¹/₁₆" TIE ROD (SCM45°)
- 1PC- ¹⁵/₁₆" BALL JOINT (SCM45°)
- 1PC-1 ¹/₈" PITMAN ARM (SCM45°)Blow Case



KAO-30 Air Oil Pump

- Capacity: 30L
- Air Inlet Pressure: 3~6KG/CM²
- Pressure Rate: 5:1
- Fluid Output Prsssure: 15~40KG/CM²
- Oil Out: 18L/min



KOC-60 Waste Oil Changer

- Capacity: 60L
- Pressure: 3~5kgs
- Hose: 1/2"x2.5M

KOC-80 Waste Oil Changer
CAPACITY: 80L



KAV-120N Vacuum Oil Extracting Machine

- Oil is extracted by the vacuum ejector, saving the troubles of repairing the pump or the motor. Cleaning the filter net is unnecessary. Either, Oil can be directly extracted without a lifter.
- It is suitable for all the vehicles either with or without an oil-draining hole under the chassis.
- The operation is easy and fast.
- It can be used to extract a variety of lubricant, gear oil, engine oil, gasoline oil, diesel oil, water and neutral liquid.
- Use the vacuum ejector to extract oil by air pressure. It can store pressure and extract or drain oil at any place.
- Capacity: 12L
- Machine Size: 285 x 250 x 860
- Hose:

- | | | |
|---------------------|--|--|
| A: 6 φ x750L | | |
| B: 7 φ x750L | | |
| D: 7 φ x920L | | |
| E: 3/8" φ x650L | | |
| F: Braking oil tube | | |



Extracting oil is clearly visible



KA-120T
Parts Washer With Turbo

- Capacity: 20 Gallons
- Solvent capacity: 12 Gallons
- Flow rate: 50 Gallons
- Packing: 1 set/28kgs/ 30 kgs/5.5'
- Size: 31-7/8"L x 20-7/8"W x 35-3/8"H



KA-130
Parts Washer

- Capacity: 30 Gallons
- Solvent capacity: 20 Gallons
- Flow rate: 50 Gallons
- Packing: 1 set/34kgs/ 36 kgs/7'
- Size: 37-1/2"L x 21-1/4"W x 35-3/8"H



KA-140
Parts Washer

- Capacity: 40 Gallons
- Solvent capacity: 30 Gallons
- Flow rate: 50 Gallons
- Packing: 1 set/42kgs/ 45 kgs/8'
- Size: 45"L x 21-1/4"W x 35-3/8"H



KA-130A
Air Power Parts Washer W/Turbo/Blower Gun

- Bucket Capacity: 30 Gallons
- Solvent capacity: 20 Gallons
- Flow rate: 75 Gallons
- Maximum speed: 11000rpm
- Range of working pressure: 65-125PSI
- Air inlet port: 1/4"
- Packing: 1 set/34 kgs/36 kgs/ 7'
- Size: 37-1/2"L x 21-1/4"W x 35-3/8"H



KA-120A
Air Power Parts Washer W/Turbo/Blower Gun

- Bucket Capacity: 20 Gallons
- Flow rate: 75 Gallons
- Solvent capacity: 12 Gallons
- Maximum speed: 11000rpm
- Range of working pressure: 65-125PSI
- Air inlet port: 1/4"
- Packing: 1 set/28 kgs/30 kgs/ 5.5'
- Size: 31-7/8"L x 20-7/8"W x 35-3/8"H



KA-140A
Air Power Parts Washer W/Turbo/Blower Gun

- Bucket Capacity: 40 Gallons
- Flow rate: 75 Gallons
- Solvent capacity: 30 Gallons
- Maximum speed: 11000rpm
- Range of working pressure: 65-125PSI
- Air inlet port: 1/4"
- Packing: 1 set/42 kgs/45 kgs/ 8'
- Size: 45"L x 21-1/4"W x 35-3/8"H



KA-115H
Deluxe Sand Blaster Cabinet (Floor type)

- Work capacity: 30 Gallons
- Range of blasting pressure: 65-125PSI
- Maximum pressure: 250PSI
- Hose size: Ø 1/2"
- Ceramic nozzle: Ø5, 6, 7mm
- Packing: 1set/ 36kgs/45kgs/9.8'



KA-103S
Mini Portable Sand Blaster

- Tank capacity: 3 Gallons
- Tank diameter: 255mm
- Tank thickness: 0.3mm
- Tank material: Stainless
- Range of blasting pressure: 50-150 PSI



**KA-103P
Mini Portable Sand
Blaster**

- Tank capacity: 3 Gallons
- Tank diameter: 215mm
- Tank thickness: 2.0mm
- Tank material: Plastic
- Range of blasting pressure: 50-150 PSI



**KA-215A
Sand Blaster**

- Bucket material: LLDPE
- Bucket thickness: 5mm
- Bucket capacity: 5 Gallons
- Bucket Diameter: Ø 280mm
- Overall height: 700 mm
- Packing dimensions: 570(L) x 330(W) x 330(H) mm
- Measurement: 2.1 cuft
- Net weight: 5 kgs
- Gross weight: 6 kgs
- Nozzle: Ø 5, 6, 7mm



**KA-215V
Vacuum Blaster**

- Tank capacity: 5 Gallons
- Tank diameter: Ø280mm
- Tank thickness: 5mm
- Tank material: Plastic
- Range of blasting pressure: 62-125 PSI
- Air hose size: 3/8"
- Blast hose size: 1/2"
- Suction hose size: 1-1/4"
- Nozzle size: 5mm
- Net weight: 11kgs
- Gross weight: 12kgs
- Packing dimensions: 2.1 cuft



**KA-250V
Sand Dust Collector**

- Tank capacity: 5 Gallons
- Tank diameter: Ø280mm
- Tank thickness: 5mm
- Tank material: Plastic
- Suction pressure: 62-125 PSI
- Max. flow rate: 24 CFM
- Air connector: 1/4"
- Suction hose size: 1-1/4"
- Net weight: 7kgs
- Gross weight: 8kgs
- Packing dimensions: 2.1 cuft



KA-01CP Electric Coolant Pump

- 1/15 HP motor drive
- Suitable for bench lathe, drill press, bench mill, tool grinder etc
- Magnetic base conveniently secure flexible nozzle to working machine surface
- 2 Gallons PE tank
- A valve for convenient flow on/off control
- Maximum coolant flow rate 22 l/min
- 1/4" dia. 8 feet long plastic hose
- Screen is removed easily for fast cleaning



KA-01NC Electric Coolant Pump

- Bucket capacity: 2 Gallons
- Suitable for bench lathe, drill press, bench mill, tool grinder etc
- Magnetic base conveniently secure flexible nozzle to working machine surface
- A valve for convenient flow on/off control
- Maximum coolant flow rate 18 l/min
- 1/4" dia. 8 feet long plastic hose
- Screen is removed easily for fast cleaning



KA-111 Hand-Held Sand Blaster

- Sand reservoir capacity: 1kgs (2.2 lbs)
- Ceramic nozzle diameter: Ø5 mm
- Air inlet size: 1/4 NPT
- Air source pressure: 60-125 PSI
- Working pressure: 90 PSI
- Air consumption: 5 CFM
- Air compressor horsepower: Over 1 HP
- No load weight: 0.6kgs
- Full load weight: 1.6kgs
- Applicable sand sizes: 16-180 grit

1. It is suitable for removing and cleaning any kind of chip or foreign material on workplace.
2. It would be the convenient tool for those fields: machinery, workshop, wood workings, décor and household.
3. It is ergonomic design and stringent quality control makes this product winning the praise from customers.

PA-9692 20" (500mm)

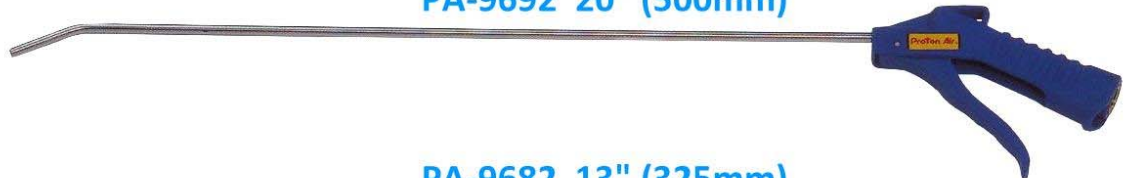

PA-9682 13" (325mm)

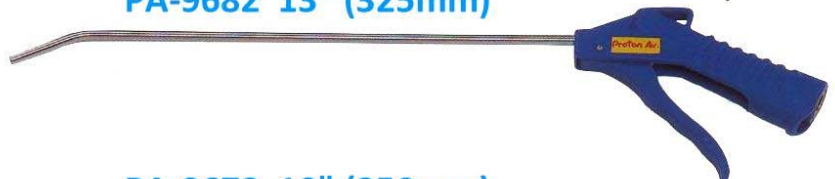

PA-9672 10" (250mm)



PA-9662 4" (100mm)



PA-8692 20" (500mm)



PA-8682 13" (325mm)



PA-8862 4" (100mm)



PA-6521 12" (305mm)

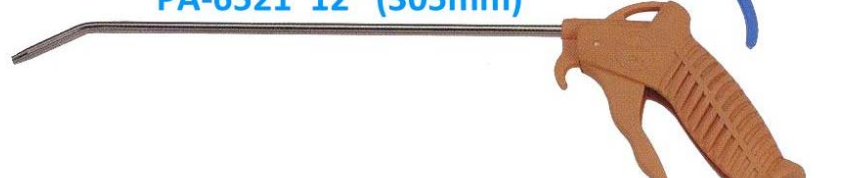

PA-6520 5.4" (135mm)



SPECIFICATION:

- Body Material: Plastic P.O.M
- Nozzle Material: steel
- Working Pressure : 75~100PSI/5.1~7.5KGS
- Sound Pressure:85~88dB
- Air Consumption(90PSI)
 - 1/4" Hose~13CFM-350/min
 - 3/8" Hose~15CFM-430/min
- AIR INLET THREAD:
SEA SIZE: 1/4" NPT
Metric Size: 1/4" PT



PA-2220 Extendable & Angles Swivel Air Blow Gun

- It is suitable for removing and cleaning any kind of chip or foreign material on workpiece.
- It would be the convenient tool for those fields: machinery, workshop, wood working, decor and household.
- It's ergonomic design and stringent quality control makes this product winning the praise customers.
- Short tube blow gun
- Long tube blow gun
- Angle swivel blow gun
- Quick and easy setting for operation
- Adjustable length: 6 1/2" - 11" (165mm-280mm)
- Tube position switch knob

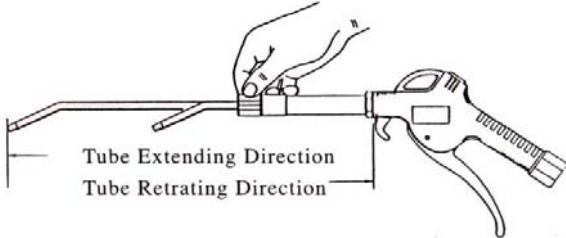

Swivel tube in all directions

Extending reach on narrow surface area dusting/cleaning

As well as dusting/cleaning on hard reaching area

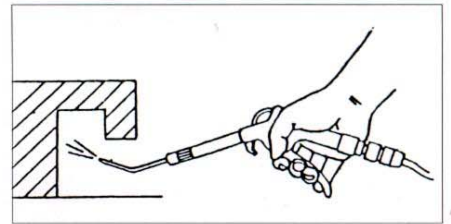
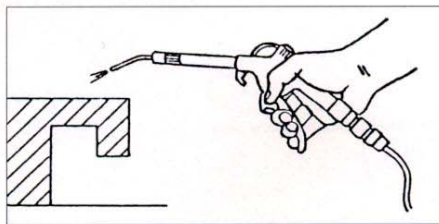
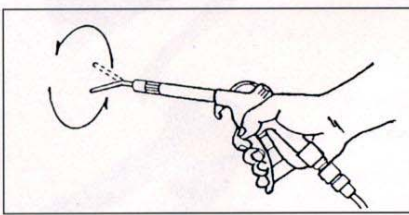

PA-2102 4" Adjustable Air blow Gun

All item specification:

- Body material: plastic P.O.M
- Nozzle material: steel
- Working pressure: 75~110PSI / 5.1~7.5KGS
- Sound Pressure: 85~88dB
- Air consumption(90PSI)
 - 1/4" Hose ~ 13 CFM - 350/min
 - 3/8" Hose ~ 15 CFM - 430/min
- Air inlet thread:
 - Sea size:1/4" NPT
 - Metric size:1/4" PT
 - Multi nations pat



PA-9203 2 IN 1 Air Blow Gun



PA-9103 2 IN 1 Air Blow Gun



AIR INFLATOR CHUCK

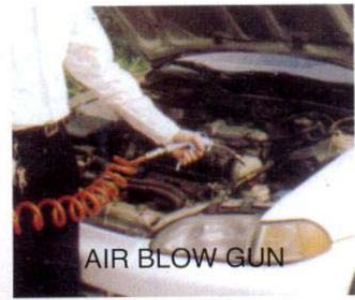

AIR BLOW GUN

Application: Auto Repair, Repair, Construction, Boat, Workshop, Industrial



KA-4150 1/2" Dr. Cordless Impact Wrench Set

- 18 V 1/2" Dr. Cordless Impact Wrench
- Professional charger (charge time: 1hr)
- Battery (Japan-made 2.0Ah Ni-Cd) OR (China-made 2.3Ah-Mh Battery)

Specification

- Voltage: 18V DC
- No-Load Speed: 0-1850 RPM
- MAX. Tightening Torque: 400 ft/lbs
- Tightening Torque: 300 ft/lbs
- Impact Per Minute: 2600 BPM
- Tool Weight: 3.0 KGS
- Capacity (SQ Dr.): 12.7±0.005mm
- Charging Time (Simple): 4-5 hr
- Charging Time (Professional): 1 hr
- Charging Voltage:
- Japan:100V 50/60c/s, Europe:220V 50c/s
- Australia: 240V 50c/s, N.America: 115V 60c/s

Optional Accessory:



KA-4150-1

Professional Charger
Charging Time: 1 hr



KA-4150-2

Simple Charger
Charging Time: 4-5 hr



KA-4150-3

2.3 Ah-MH Battery
Made In China



KA-4150-4

2.0 Ah-Cd Battery
Made In Japan



KA-4151 1/2" Dr. Cordless Impact Wrench Set

- 18 V 1/2" Dr. Cordless Impact Wrench
- Simple charger (charge time: 4-5hr)
- Battery (Japan-made 2.0Ah Ni-Cd) OR (China-made 2.3Ah-Mh Battery)

Description

- 18V High Torque 4100 kg/cm (300ft-lb) Heavy-Duty Impact Transmission
- Compatible model Chicago Pneumatic CP8745, DEWALT DW059K-2, Milwaukee 9079-20. Snap-On CT3850, Ingersoll-Rand 2530K
- 18 Volt Cordless 2.3Ah Ni-MH
- Nylon/ Glass Fiber & Aluminum Housing
- A Soft-touch variable speed switch
- An easy-to use forward/reverse switch



KA-1043 Auto Alarm Simulator

- Size: 3.5 x 6.5cm
- Color: black body with red flashing bulb
- Wire length: 200cm
- 1pc double adhesive tape
- Use for auto from 6 -15 V system



KA-1044 Auto Alarm Simulator

- Size: 1.4 x 3.0cm
- Black Body with red flashing bulb
- Wire length: 200cm
- Double adhesive tape
- Use for auto from 6 -15 V system



HBA-38 Reflectors Door Guard



No more scratched doors.
 Safety reflector.
 3M super bright reflector with 3M double side adhesive tape.
 Soft material & 18mm thickness real protect car door.



HBA-37SD Stop-Block-Chock



- Dimensions: 40.5 x 20.5 x 12cm
- Capacity: 3 tons
- Do not use at unfirm surface



KA-7267 Flexible Funnel



- Flexible funnel provides easy job for draining or refilling wide kinds of fluid and oil.
- Suitable application: engine oil, coolant, brake oil, auto transmission oil...etc.
- Easy to bring anywhere, use to limited space and easy storage.
- Temperature range: -35°C and 105°C / -31°F and 221°F

Specification:

- Length: 372mm
- Width: 170mm
- Inside material: Aluminum
- Outside plastic material: NBR

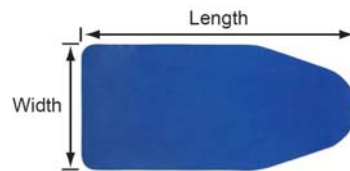

Easy Storage & Clean

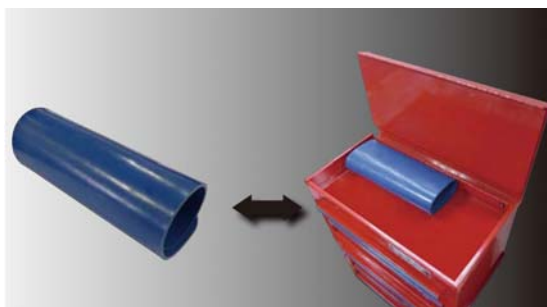

How to operation tool

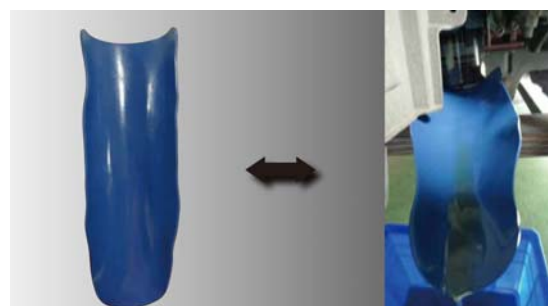
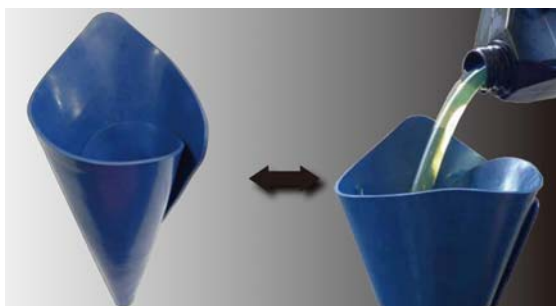

Refill Pressure Sprayer

- Ideal for lubrication, paint, clean dust, antirust...etc.
- 2 function design for easy to operation.
- Long type nozzle suitable for narrow & difficult space spray.
- Refill pressure with universal adapter for easy to stuff air pressure.
- Provide with the safety valve on the air inlet set. Pre-setting 90psi (6.3bar)
- The exceed pressure will be release automatically.

- 👍 **Long type nozzle: Straight Hydraulic**
- 👍 **Short type nozzle: Nebulization**

Noticed: Keep out of reach of children.
Always wear eyes protection when operating or performing maintenance on this tool.
Do not use with strong chemical or corrosive fluid.



Max. Capacity	650c.c.	620c.c	620c.c
Canister Material:	Stainless steel canister	Aluminum Canister + Coating	Aluminum Canister

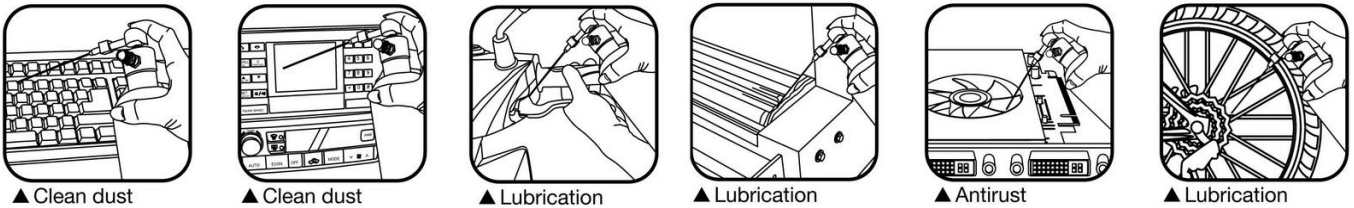
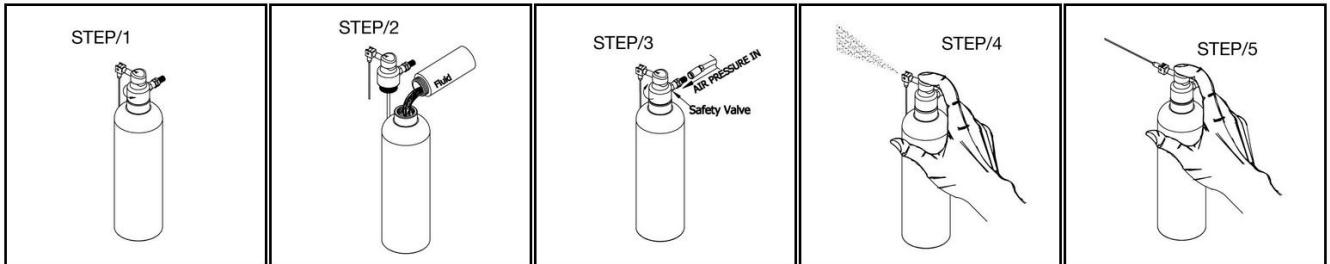

▲ Clean dust ▲ Clean dust ▲ Lubrication ▲ Lubrication ▲ Antirust ▲ Lubrication

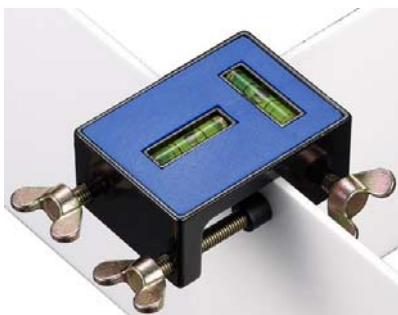

KA-2069 Parallel Welding Clamp (4pcs/set)

- Precise alignment of work piece in 'L', 'T', or 'I' configuration.
- Integral bubble level ensures accuracy of alignment.
- Wing bolts feature protective tips, preventing damage to surface of work piece.
- Effective, handy and easy to use.
- Material: Zinc alloy.

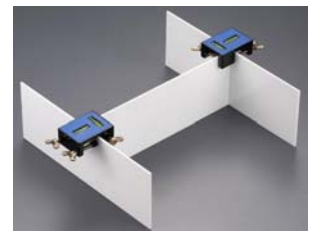

KA-2090 Magnetic Ruler

Sticks to magnetic metal surface measure irregular shape size flexible.

How to use the middle scale to measure radian:

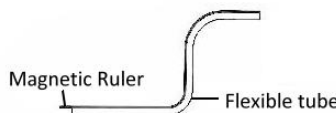
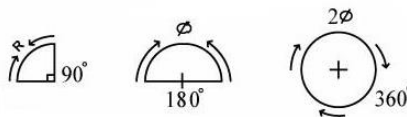

SUITABLE FOR: Sheet metal range, Flexible tube range, Automobile range

- Size: 605mmL
- Width: 21mm
- Body: magnetic
- Specification: MM, Inch, R-angle

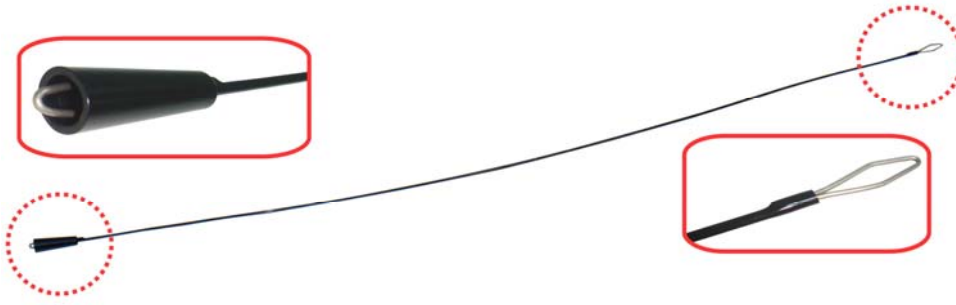

- KA-3117 Length: 730mm
- KA-3117A Length: 1000mm
- KA-3117B Length: 1500mm

Wire Installer

Feature:

- Designed for quick and easy installation of wires.
- Convenient, Easy
- Suits for most wire installation work, (e.g. use in cars, trucks, motorcycles, plane, stereo systems, alarm systems, cellular phones, vacuum hoses, and air shock supply lines...etc)
- Eyelet shaped collet provides secure wire retention when threading wires. Will push or pull wires through openings.

Operation:

- (A) Thread about 1" of the wire/hose through the eyelet of this tool. Fold the wire/hose to the end of wire till parallel.
- (B) Slide the plastic cone collet up over the eyelet to lock in the wire.
- (C) For extremely confined areas, where the wire is too large to pass through. Thread about 1.5" of the wire/hose through the eyelet of this tool. Fold the wire/hose to the end of wire till parallel, then warp the wire with electrical tape in spiral motion.

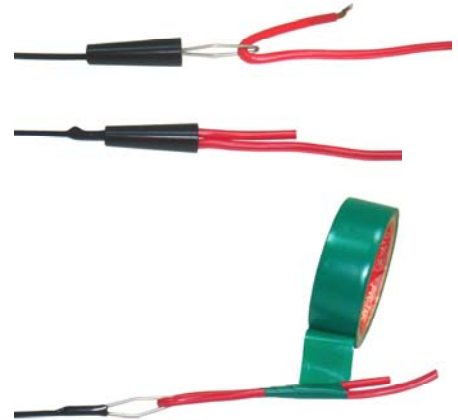

- *Push and rotate the tool slowly when tool does not move smoothly through obstructed areas.
- *Please always disconnect vehicle power before using this tool.
- *Please always wear eye protection when using this tool.

<p>Air Shock Installation</p>	<p>Engine Compartment</p>	<p>Headliner</p>
<p>Car's Door</p>	<p>Truck Visor</p>	<p>Dash Board/Console</p>
<p>Floor Carpeting</p>	<p>Cowl</p>	<p>Car's Fire Wall</p>



KA-KI472 Extra Heavy-Duty Grease Gun (Iron head)

1. Drop resistant steel head design with robust and durable construction
2. Working Pressure: up to 6,000 psi
3. Burst Pressure: 10,000 psi
4. Delivers Minimum: 1 oz. / 40 strokes
5. Loading way: 14 oz. Cartridge / 400c.c. Bulk / Dispenser.
6. Capacity: 14 oz. / 400c.c.
7. W/ Air Vent Valve & Filler Plug
8. W/ Black Grip

KA-KTPL479N Extra Heavy-Duty Twin Piston Grease Gun



1. Dual Piston with high volume performance
2. Working Pressure: up to 3,600 psi
3. Burst Pressure: 6,000 psi
4. Delivers Minimum: 3 oz. / 40 strokes
5. Loading way: 14 oz. Cartridge / 400c.c. Bulk / Dispenser.
6. Capacity: 14 oz. / 400c.c.
7. W/ Air Vent Valve & Filler Plug
8. Variable Stroke: Available
9. W/ Black Tube Holder
10. W/ Black Grip



New Paten designed
 — Twin-Piston
 Easy operation, double output
 volume(2.15c.c/per stroke)

KA-A501 Oil Suction Gun



- Designed for all purpose quickly draining and filling device oil and other fluids for clutches, agricultural, and industrial chemical, additives, transmission on differentials, brake master cylinders, oil filters or other type of sumps or sampling engine oil. Needs no priming.
- Features 11" (28cm) flexible hose and durable corrosion resistant finish.
- Capacity: 500 c.c.

KA-AL504 Heavy-Duty Dual Transfer Pump



1. Aluminum construction of container tube and durable plunger.
2. Two way vinyl hoses for suction and discharge of fluids.
3. Durable check valve.
4. Capacity: 500 c.c.
5. Equipped with 2 pieces flexible plastic hose.
6. Ideal for emergency gas transfer directly from one vehicle to another. Also for draining oils and other fluids. Portable, easy to operated, for farm, automotive, home and factory use.



KA-1353 Tire Chain Chock

- For fitting snow chain or ensures safe parking on steep slopes.
- Suitable for all cars, vans, RV, light trucks,...etc.
- Indispensable for every vehicle.
- Dimensions: 37(L) x 21(W) x 7.8(H) cm.
- Material: PP



KA-1351 Instant Traction

- Never get stuck again for use in snow or mud.
- Made of high impact plastic and brass.
- 1 pair /2 pcs over 44" long.
- For cars, vans and light duty trucks.
- The long sections have traction surfaces that provide the necessary grip to vehicle unstuck.
- Cold resistance: -30°C

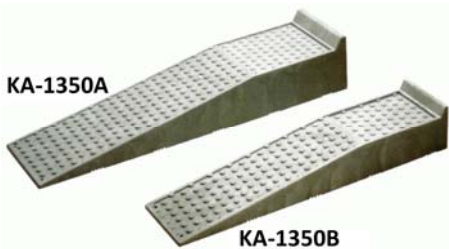
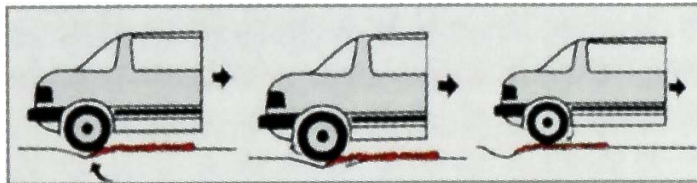

Car Service Bridge

Item No.	Maximum load	Dimensions (L x W x H)
KA-1350A	10 tons	120 x 29 x 17 cm
KA-1350B	10 tons	100 x 23 x 13 cm
KA-1350C	3 tons	91 x 30 x 17 cm
KA-1350D	15 tons	120 x 29 x 20 cm

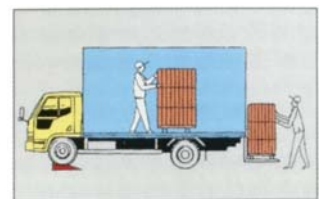

KA-1352PS Pallet Stopper

- Material: heavy impact PP.
- Dimensions: 27 x 16.5 cm.





KA-1352D Stopper & Protector

- Stop sign 1pcs: 55(L) x 28(W) cm
- Ensure the correct position of the vehicle in the garage before affixing the stop sign to the floor.
- Doors & Fenders protector 2 pcs: 7.5 x 28 x 3.5 cm.
- Material: 3.5 cm thick, providing effective cushioning.

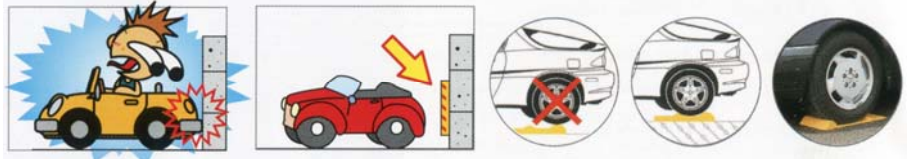

KA-1352S Stopper

- Material: Impact PP, Rubber.
- Dimensions: 17.5 x 12.5 x 10.5 cm.

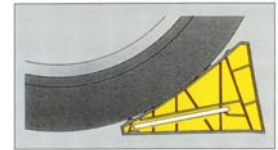
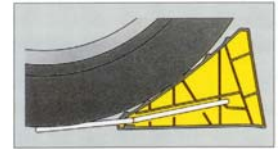

KA-2176 One Hand Silicone Remover

- For scraping, cleaning and peeling silicone in all occasions.
- Easy and simple use, one hand operation.
- Built by composite plastic, strong enough to do the job.
- Will not damage surface material during the operation.

Specification:

- Dimension: 212 x 34 x 25.5mm
- Weight: 393g
- Material: POM



Push the remover backward to scrape the silicone.



Pull the remover backward to peel the silicone.



KA-2178 Parts Washing Brush

- Replacement flow through brush for most popular parts washer
- Solid nylon handle.
- Curved



KA-9056 Hose Slide (2pcs/set)

- Keep away from the hose or cord kinds of material crushed tightly under the tires.
- Efficient design for car washing and time saving.
- Fits nearly for any sizes of tire.
- Additional two holes could be fixed on the ground and applied in outdoor activity as agriculture work.
- UV proof.
- Chemical Resistant.
- Made out polyethylene plastic, extremely durable.





Release Magnetic Sweeper With Wheels

- Release magnetic sweeper has a magnetic device which enables to attract any metal items and spare parts laying on the ground without picking them up one by one.
- Pull the trigger to release magnetic force.
- Easy to use, safe and practical times saving device.
- Permanent magnet.

Model	KA-2682A	KA-2682B
Rod Size	720~1035mm / 28-1/4" ~ 14-1/2"	
Total Width	377mm / 14-1/2"	
Max. Capacity	About 3.5kgs	About 6kgs



KA-2682A

KA-2682B

Magnetizer & Demagnetizer

- To magnetize, insert tip of screwdriver into hole of magnetizer.
- To demagnetize, rub tip of screwdriver along slot on top of / demagnetizer until completely demagnetized.



KA-2681A size: 25 x 25 x 25mm

KA-2681B size: 80 x 25 x 10mm



KA-2681A



KA-2681B



Magnetize



Demagnetize



KA-1328 Handy Pitch Gauge

- 3-in-1 functions: diameter, pitch, length.
- Suitable for male parallel bolts, studs and screws.
- Includes most common sizes in metrics and SAE.
- Convenient tool avoids incorrect bolt, stud or screw installation.
- Material: ABS.

Instructions:

For checking threads

1. Find a hole with a similar size to the object (a bolt, stud or screw to be checked) (fig.1)
2. Connect the object to the hole to see if the hole matches the object.

Note: when the object threads match hole threads, the object can be rotated smoothly. If un-smoothness occurs, it is an indication that the threads do not match. Connection with force may cause hole threads damaged.

For checking diameter

1. Position the object against the innermost part of the V-shape groove.
2. Find the point where the edges of the object and the gauge touch each other (see the arrows on fig 2), and read the marking.

For checking length

1. Place the object on both sides of the gauge (SAE on the right and metrics on the left).
2. One end of the object should align the upper line of the gauge (fig.3 and fig.4) and read the marking.

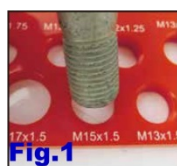

Bumper Stand K/D Type

- Can put wood, iron, bumper car door window glass.
- The supporting frames 5mm EVA, placeable items non-slip, scratch-resistant shockproof role.
- Can be used in car of sheet metal spray etc.

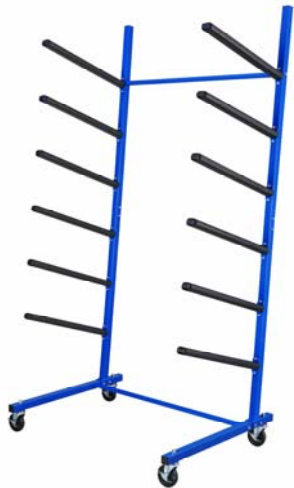

KT-1206

- Size: 110 x 80 x 240 cm
- Can with stand the weight of 240kg.



KT-1203

- Size: 110 x 80 x 40cm
- Can with stand the weight of 120kgs



KA-4507 Mini Digital Protractor

Introduction:

This is a measuring tool that provides an immediate, digital reading of all angles in a 360° circle. It is easy to be carried and used for its small size and light weight. Measuring plane containing magnet material can stick to the surface to be measured. It is especially easy to measure bevel angle of miter saw, and any small area surface.

When mount on a rigid platform, this measuring tool allows the sensor and its microprocessor circuit to provide excellent accuracy throughout the Inclinator's 360° range.

Features:

- Small and portable
- Faster and more precise measurement of gradient
- Freezing readout on LCD display
- Level readout in different ways: (°, %, IN/FT)
- Easy to calibration without extra tools
- Magnetic base allows for hand free operation
- Automatic shutdown for power saving, low battery warning

Specification:

- Dimension: 50.8mm x 50.8mm x 31.0mm
- Range: 360° (90° x 4)
- Accuracy: ±0.1° (10~40°C), ±0.2° (0~10°C, 40~50°C)
- Resolution: 0.1°
- Operating Temp.: 0°C ~ 50°C
- Storage Temp.: -10°C ~ 60°C (14°F ~ 140°F)
- Battery: 3V CR2032 x 3
- Weight: 130g



KA-1355 Under Hood Light Bracket

- The under hood bracket telescopes from 112cm to 180cm to fit most vehicles.



Finger Nail Brush for Mechanics

Fun and Easy Way to clean your hands!!

Description:

The Finger and Nail Brush is specially designed to clean the finger and nails of mechanics. Wet your hands with soapy solutions, insert your hands, twist and rotate and comes your clean hands!!

Kingtool Finger and Nail brush is a wonderful gadget that every mechanics shall have!!

Feature:

Each bundle is meticulously arranged to reach and clean the nail groove.

The brush strip could be removed and fold backward to form a hand-held brush.

KA-FB001 The strand is **staggered arranged**.

KA-FB002 The strand is **aligned arranged**.

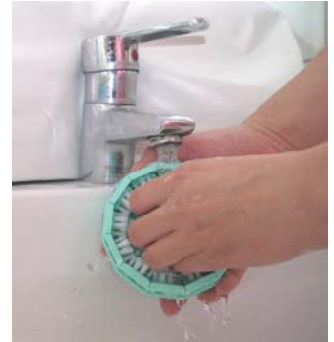
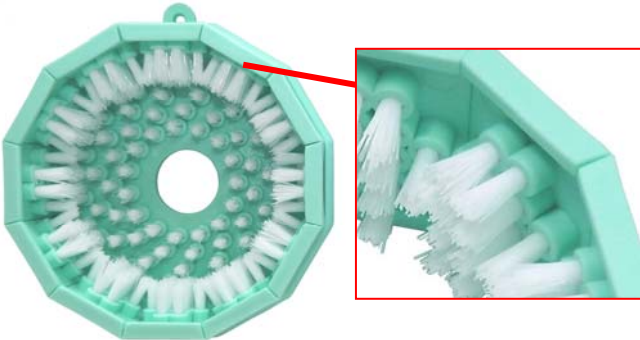
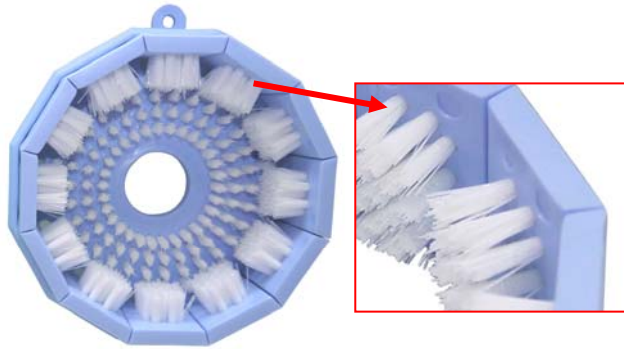

AdBlue Filling Funnel

- AdBlue filling funnel connects to all filling neck.
- Separate air breathing design for easy filling.
- Open/Close valve to stop filling once the tank is full.
- Transparent level scale.
- Funnel cover to prevent dust.

KA-7842A Straight

KA-7842B Angle



KA-7842A



KA-7842B

KA-7840 Flexible Filling Hose For AdBlue / DEF / AUS32



KT-N0004

5 In 1 Convertible Creeper With 39 LED Bulbs



Shop Seat

Shop Seat



LED Lighting



Tool Tray

- Dimensions: 43-1/4"(L) x 16"(W) x 6"(H)
(1100 mm(L) x 406mm(W) x 155mm(H))
- Weight Capacity: 450 lbs.
- PAT. USA / Taiwan
- Features:
 1. Multi-Function
 - Flat creeper
 - Shop seat
 - LED lighting
 - Tool tray
 2. Quickly and easily converts from creeper to shop seat.
 3. Six Ø3.0" swivel castors for easy maneuverability.
 4. 1" tubular iron construction with mat and lighting.
 5. LED type: 3528 SMD
 6. LED quantity: 39pcs LED white bulbs.
 7. Version with switch.
 8. Bright light despite low current draw.
 9. Mat wrinkle-Resistant, Anti-Slip.
 10. Kneeling mat also separately available.
 11. Power: AA battery x 8pcs /4pcs

KT-N0005 Convertible Creeper



Shop Seat

Tool Tray

- Dimensions: 43-1/4"(L) x 16"(W) x 6"(H)
(1100 mm(L) x 406mm(W) x 155mm(H))
- Weight Capacity: 450 lbs.
- PAT. USA / Taiwan
- Features:
 1. Multi-Function
 - Flat creeper
 - Shop seat
 - Tool tray
 2. Quickly and easily converts from creeper to shop seat.
 3. Six Ø3.0" swivel castors for easy maneuverability.
 4. 1" tubular iron construction with mat and lighting.

KA-9054 2 In 1 Creeper Seat With Adjustable Tray



- An ideal accessory for any garage, workshop or auto detailing shop.
- Durable and comfortable large (11.8") 2-1/2" thick round seat.
- 17" to 21" pneumatic gas lift seat height adjustment makes this creeper versatile for a variety of work environments.
- Rugged steel construction with padded cushion seat for durable use and a comfortable seat.
- Tool tray can rotate 360°.
- Tool tray can with adjustable hydraulic rise / fall.
- Dimensions: 530mm(H) x 380mm(W)
- 5pcs 3.0" heavy duty construction wheels.
- Weight Capacity: 350 LBS
- Pat.: Taiwan, China, U.S.A. / patent pending: Germany



Rotate 360°
with the cushion can lift tool tray

48"

36"

24"

12"

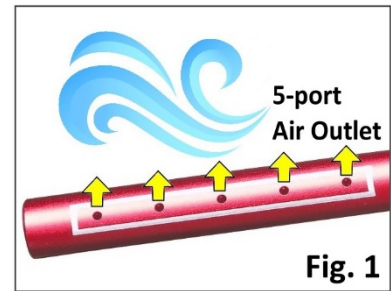

Tube-Type Cleaner With Air

- Tube type cleaner with compressed air to clean hard-to-access areas, such as filters and radiator.
- 90° angle and 5-port air outlet to increase accessibility and maximize air pressure and volume (Fig. 1).
- Ergonomic handle design enables users to control the air direction easily and work with the tool comfortably (Fig. 2).

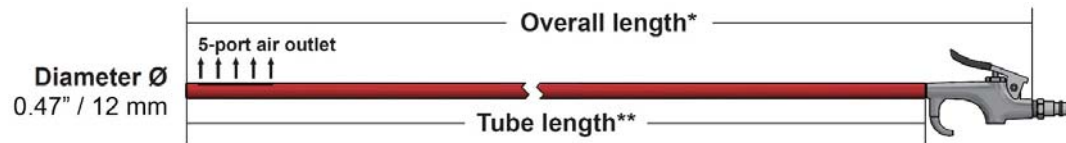

Specification:	
Tube material	Aluminum
Working Pressure	90 psi / 6.2 bar
Max. pressure	170 psi / 11.7 bar
Avg. air consumption	5 CFM / 140 LPM
Inlet threads	1/4"

Item No.	KA-4123-12	KA-4123-24	KA-4123-36	KA-4123-48
Tube length	12"	24"	36"	48"
Tube length	304mm	609.6mm	914.4mm	1219.2mm
Overall length	15"	27"	39"	51.1"
Overall length	383mm	688mm	993mm	1298mm
Tolerance	±0.08" / ±2mm			

Instructions:

1. Connect shop air to the cleaner tool.
2. Insert the tube to the car part or area to be cleaned (Fig 3).
3. Use one hand to hold the tube for stabilization during operation (Fig 4).
4. Use the other hand to hold the handle.
5. Press the trigger to introduce air into the tool to clean.

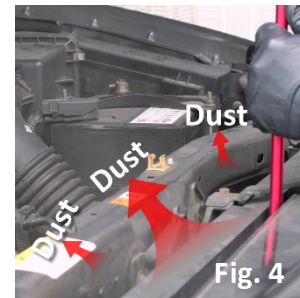

KT-317K Fold-Up Mini File Set

- 12 different file shapes. Including: round, half round, flat, knife, triangle, square, barrette, jointing, slitting, marking, equalizing and crossing.
- Each file is locked in firmed position by a unique "push button" system while in use.
- Simply press a button, the file folds out and into the body handle.
- The "compact slide-apart mechanism" makes two halves separated but also held together easily via an interlocking channel.



KA-9065 Magnetic Grounding Block

- Diameter 3-3/4".
- Ground your arc welder fast no matter what you are welding.
- Your grounding clamp connects directly to the bolt and the bolt to a high powered magnetic base that will literally stick to anything you weld.
- Perfect for pipe and pieces your grounding clamp can't fit around.



KT-GT347 Grommet Tool Kit with Hole Punch Set

- Fast And Easy To Change Upper and Lower Dies.
- No Need to Adjust The Dies After Installation.
- Install Variety of Grommets, Eyelets, Snap Buttons with Suitable Dies.
- Easy To Operate and Save Efforts.
- Hole Punches Up to 10 Sizes Help You To Make Perfect Rounds On Tents, Canvas, Leather....Etc.



Clamp on Table Edge



Hand-held Hole Punch



Hole Punch



Hand-held Operation



Fastened on Table



Small Hole Punch

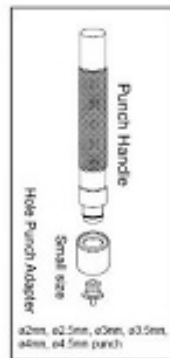
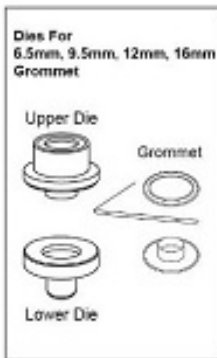
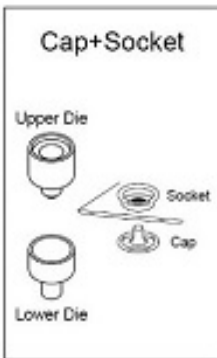
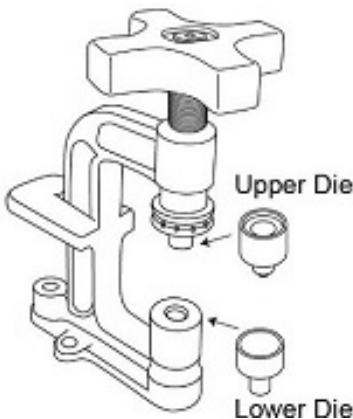

Contour Gauge

- **Instant template**
Works well in copying the shape of irregular items, replicate the shape of moldings or match cut outs, providing you with accurate reads.
- **Flexible shaping measure ruler**
This contour profile gauge can be applied to copy or track the shape of irregular objects, with ruler on the top, you can quickly figure out the size of them, instant template for marking precise tile cut.



KT-2908 5"
KT-2908A 10"





4" Smart Air Regulator Air Blow Gun - 4 Types Available !!

- Heavy Duty & Lightweight!!
- Made of Composite Material.
- 4" Smart Air Blow Gun
- Innovative Mass Flow Design
- Max Pressure: 200 psi, 14 kg/cm²
- Air Inlet: 1/4" NPT
- Temperature Range: -40°C~60°C (-40°F~140°F)
- 4 Nozzles Types Available

KA-1388A Smart Air Blow Gun with Protect Nozzle



KA-1388B Smart Air Blow Gun with Wide Range Blow Nozzle



KA-1388C Smart Air Blow Gun with Adjustable Blow Nozzle



KA-1388D Smart Air Blow Gun with Silence Noise Nozzle



KA-9999
Smart Spray Trigger Grip Handle

A Dream Handle to Make Spraying so EASY !!
Simply Clip on! Spray on and Have Fun !
A Gadget makes working like playing !!
Patented !!

- Suitable & Fit for **All Standard Aerosol Cans**: *Paint * Lubricant * Wax Cleaner * Adhesives * Party Foam * Bug/Insecticide...etc



- Large Spring-Trigger allows continuo and even spraying.
- Ergonomic Design Reduce Finger Fatigue.
- Easy to Assemble. Light Weight: 89.0 gram



Comparison:



Grip Range:

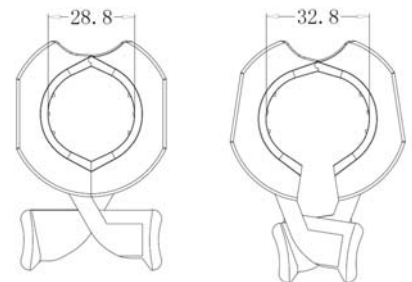

28.8mm~32.8mm
 Handle Size: 150x150x53mm

Spray without Smart Handle	👍 Spray with Smart Handle
Sore finger and hand	Spring-Trigger Saves Effort, reduce Finger Fatigue
Finger stained by paint drip	Keep your hands clean
Uneasy to control spray	Easy to control spray
Unevenly spraying	Evenly Spraying

1. Pinch the Grip	2. Fasten over can nozzle	3. Face Nozzle Forward

Fuel Tank Funnel for Cap-less Filler system



Item No. KA-7854

- For Petrol
- Fuel Funnels for cap-less filler systems of Ford vehicles
- Securely fits in filler neck, opening two valve security systems.
- D: 24.5mm



Item No. KA-7855

- For Diesel
- Fuel Funnels for cap-less filler systems of Ford Vehicles.
- Securely fits in filler neck, opening two valve security systems.
- O.D: 24.5mm



KA-6993 5-IN-1 Caulk Finishing Tool

- Smooth the bead of sealant such as silicon & acrylic
- Idea for floor, kitchen, bathroom and window sealing jobs.
- Can be used repeatedly and easy to clean.
- Compact design with 5 shapes of spatulas.
- Size: 135*20*21mm





KA-5146 Flexible Inspection Mirror Tool

- L: 470mm (18.5")
- Mirror: 55mm



KA-5147 Inspection Mirror Tool

- L: 370mm (14.5")
- Mirror: 2-1/4"



KA-5148 Inspection Mirror Tool

- L: 270~535mm
- Mirror: 30mm



KA-5151 Ultra-Thin Flexible Light

- L: 650mm + Handle 450mm



KA-6474

Flexible Inspection Mirror W/Magnetic Pick Up Tool

- Capacity: 3.5lbs(1.6kgs)
- Length: 590mm(23.6")



KA-6460 Flexible & Stick Inspection Steel Mirror

- Mirror: 40mm(1.6")
- Length: 275mm(11")



KA-6475 2-IN-1 Magnetic & Mirror

- Magnetic: 1.1lbs
- Length: 185mm - 540mm (7-1/4" to 21-1/4")
- Mirror 32mm DIA.



KA-5150 5-IN-1 Telescoping Magnetic Pick-Up & Mirror Tool

- Magnetic Capacity: 8.0~5.5~1.5Lbs
- Mirror: 30mm & 85 x 45mm
- L: 170~762mm



KA-6478 3-IN-1 Lighted/Magnetic/Mirror

- 25 x 50mm swivel inspection mirror & magnetic retriever
- Length: 500mm



KA-6467 Telescoping Inspection Mirror Tool

- Mirror: 50 x 90mm (2"x3-1/2")
- Length: 290-430mm (11.6"-17.2")



KA-6468 Telescoping Inspection Mirror Tool

- Mirror: 63mm (2-1/2")
- Length: 280-580mm (11.2"-23.2")



KA-6469 Telescoping Inspection Mirror Tool

- Mirror: 25 x 50mm (1" x 2")
- Length(including mirror): 140 - 550mm (5-1/2" to 21-3/4")
- 5-section extends mirror rods with pocket clip.



KA-6471 Telescoping Inspection Mirror Tool

- Mirror: 32mm
- Length: 210 -540mm



KA-6472 2 IN 1 Inspection Mirror & Magnetic Tool

- Mirror: 38mm
- Length: 210-700mm
- Capacity:1.1lbs



KA-6464

Combination Multi-Function Inspection Mirror

- Inspection mirror
- Moveable light w/magnetic
- Wiper water cleaner jet
- Mirror: 30 x 50mm
- Length: 305 - 720mm



KA-6463 Telescoping Inspection Steel Mirror Tool

Mirror: 30 x 50mm
Length: 305 - 720mm



KA-6462 Flexible & Telescopic-Stick Inspection Steel Mirror W/Light

- Mirror: 70mm (28")
- Length: 355mm -750mm (14.2"-30")



KA-6461 Flexible & Telescopic-Stick Inspection Steel Mirror W/Light

- Mirror: 50mm (2")
- Length: 355mm -730mm (14.2"-29.2")



KA-2990 Telescope Security Mirror

- Adjustable, convex, 8" acrylic mirror has a 180° view angle
- Telescope aluminum rod, 660~1280mm, light to carry and grip
- Checking under vehicles or equipments at security checkpoints
- Security mirror helps to estimate blind spots
- Easy to use and storage in workplace
- Ergonomic handle for comfort

Specification:

- Length: 660~1280mm
- Convex Mirror: Ø8" (20.32cm)
- Material of mirror: Acrylic
- Handle grip material : TPR
- Weight: 0.6kgs





KA-2718 Flexible Magnet Pick-Up Tool

- ϕ : 3.2mm For Confined Space Jobs
- L: 525mm
- Capacity: 0.4LBS



KA-2719 Flexible Magnet Pick-Up Tool

- ϕ : 3.2mm For Confined Space Jobs
- L: 1070mm
- Capacity: 0.4LBS



KA-2886 Multi-Function Inspection Tools

- 1PC-Aluminium Interchangeable Handle
- 1PC-Inspection Mirror
- 1PC-6 lbs Magnetic retriever
- 1PC-10" flexible adapter
- 1PC-9" 135 degree bended adapter
- 1PC-8" straight adapter
- 1PC-UV light
- 1PC-LED light
- PACKING: (w/o battery)
- EVA foam-lined plastic case + color box
- 24 pcs/ctn; 14.5/15.5kgs 1.6'



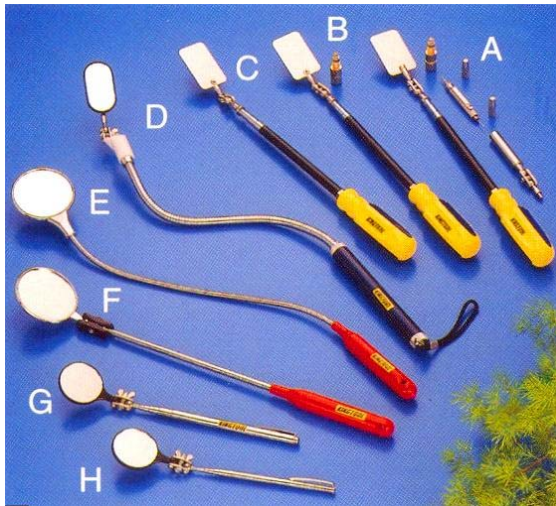

(A) KA-5201 Combination of Multi-Function Telescoping Inspection Mirror Tool

Length : 310mm to 710mm. Mirror 50mmx30mm
W/Light windshield wiper water jet outlet needle

(B) KA-5202 Telescoping Inspection Mirror Tool

Length : 310mm to 710mm. Mirror 50mmx30mm w/light.

(C) KA-5203 Telescoping Inspection Mirror Tool

Length : 310mm to 710mm. Mirror 50mmx30mm

(D) KA-5204 Flexible Mirror With Light Tool

Oval Mirror 25mmx50mm. baty Length : 500mm.
V/O battery (DC 2 AA's 1.5 voits).

(E) KA-5205 Flexible Inspection Mirror Tool

Length : 470mm. Mirror 55mm DIA. Flexible spring Steel.
Neck Allovs Vieving in Hard-to-see Areas. PVC Handle.

(F) KA-5206 Inspection Mirror Tool

PVC red handle, Mirror 55mm DIA. baty Length : 370mm.

(G) KA-5207 Telescoping Inspection Mirror Tool

Length : 145mm to 545mm. Mirror 40mm DIA.

(H) KA-5208 Inspection Mirror Tool

Length : 210mm. Mirror 38mm DIA.

(I) KA-5209 Flexible Magnet Pick-Up Tools

PVC Handle. Pick-up 3.5 LBS. Length : 460mm.

(J) KA-5210 Carburetor Adjusting Tool

For adjusting idle/mixture screws on GM & CHRYSLER

(K) KA-5211 Flexible Magnet Pick-Up Tools

Length: 59cm. Pick-up 3.3LBS.

(L) KA-5212 Flexible Magnet Pick-Up Tools

Length : 520mm. Pick-up 0.7LBS

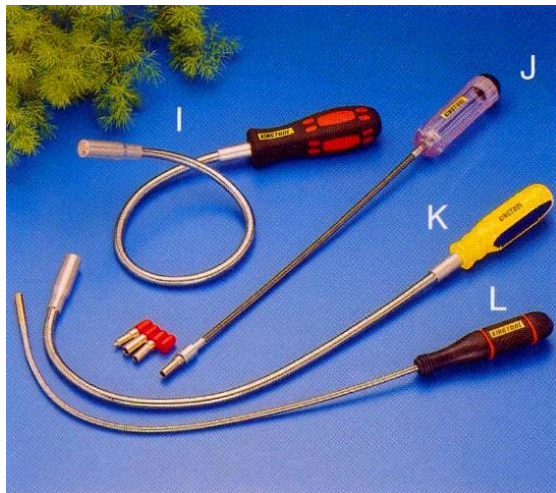

KA-5213

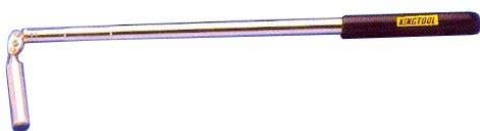

KA-5216



* Non-magnetic sleeve to pick up small parts from deep



(M) KA-5213 Telescoping Magnetic Pick-Up Tool

Length : 310mm to 700mm. Pick-up 3.3LBS

(P) KA-5216 Telescoping Magnetic Pick-Up Tool

Length : 270mm to 710mm. Pick-up 3.5LBS

Stainless Steel Magnetic Bar

KA-5141

Capacity: 8.0Lbs/3.6Kgs, L: 170~762mm

KA-5142

Capacity: 5.5Lbs/2.5Kgs, L: 170~762mm

KA-5143

Capacity: 3.5Lbs/1.6Kgs, L: 170~880mm

KA-5144

Capacity: 1.5Lbs/0.7Kgs, L: 165~880mm

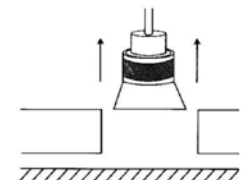
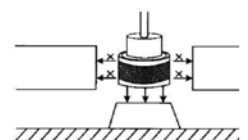



(A) KA-5217 Magnetic Moveable Light

(B) KA-5218 Multi-Function Magnetic Pick-Up Tool

- W/Windshield wiper jet outlet needle
- Pick Up 0.8LBS

(C) KA-5219 Telescoping Magnetic Pick-Up Tools

Telescopes From 130mm to 640mm. Pick-up 3.5LBS

(D) KA-5220 Telescoping Magnetic Pick-Up Tools

Telescopes From 130mm to 640mm. Pick-up 5.5LBS

(E) KA-5221 Telescoping Magnetic Pick-Up Tools

Telescopes From 130mm to 640mm. Pick-up 3.5LBS

(F) KA-5222 Telescoping Magnetic Pick-Up Tools

Telescopes From 130mm to 640mm. Pick-up 3.5LBS

(G) KA-5223 Telescoping Magnetic Pick-Up Tools

Telescopes From 125mm to 640mm. Pick-up 1.0LBS



(H) KA-5224 Rectangular Magnetic Tray

(I) KA-5225 Spare Parts Magnetic Dish – 150mm

(J) KA-5226 2pcs Magnetic Set

- 1pc 150mm MAGNETIC DISH
- 1pc FLEXIBLE MAGNETIC PICK UP TOOL
- Pick-up 3.5LBS

(K) KA-5227 Magnetic Pick-Up Tool

Length: 550mm; Pick-up 3.5LBS

(L) KA-5228 Pick-Up Tool W/O Magnetic

Length: 620mm

(M) KA-5229 Flexible Inspection Mirror

- W/Magnetic pick up tool
- Length: 580MM Pick-up 3.5LBS

(N) KA-5230

Telescope Pick-Up Tool and Inspection Mirror Set

- Feature: Brass chrome plated tube.
- Size: L = 29.5cm-45cm, L = 30cm-45.5cm

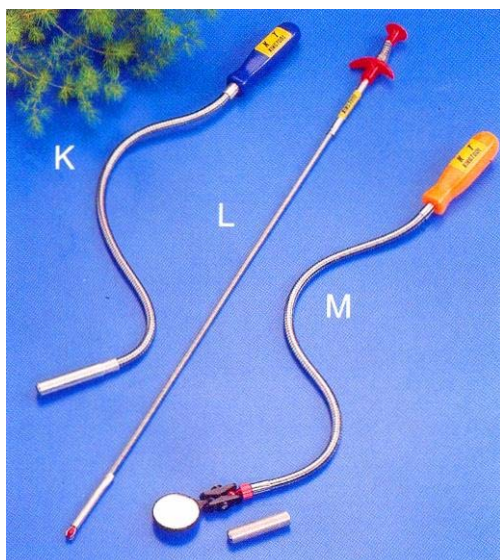



KA-5228A 3 IN 1 Pick-Up Tool

- Overall length: 24"(610mm)
- Magnetic field intensity: 1 KG
- Grab: 1 KG
- With LED light

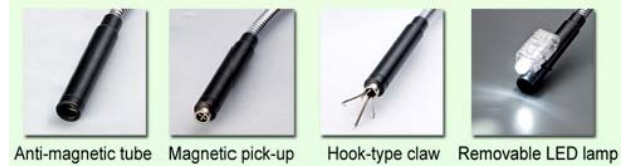

Anti-magnetic tube Magnetic pick-up Hook-type claw Removable LED lamp



KA-5228B Pick-Up Tool

- Overall length: 700mm
- Magnetic field intensity: 800g
- Grab: 1 KG



KA-5228C 3 IN 1 Pick-Up Tool

- Overall length: 700mm
- Magnetic field intensity: 800g
- Grab: 1 KG
- With LED light



KA-6328 Telescopic Magnetic Bar

W/Magnetic Handle

When repairing engine tank, you can use this bar to pick up parts if the temperature of the engine is very high.



KA-6329

Flexible Rod With Magnetic Tip Multi-Purpose Magnetic Tool Kit

- Flexible rod with magnetic tip
- Telescopic magnetic bar with magnetic handle
- Windshield wiper water jet outlet needle
- Magnetic cap opener



KA-6330 Flexible Magnetic Bar

W/Magnetic Handle

You can adjust the angle of the bar as you like, and the bar can suck hardware spare parts which fall down the place where we can not reach.



KA-6331 Flexible Magnetic Bar

W/Magnetic Handle

When repairing engine tank, you can use this bar to pick up parts if the temperature of the engine is very high.



KA-5754 Retriever Flexible Tools

- L:510mm
- Can be adjusted up to 90° angle



KA-6467-1 Telescoping inspection mirror tool

- L:370 to 810mm

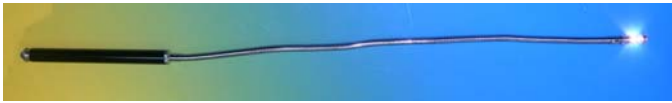

KA-3868 Magnetic Flexible Light

- L:740mm



KA-5145 Telescoping Magnetic Pick-Up Tool

- L: 360~610mm (14"~24")
- Ball joint head 90° swivel



KA-5149 Flexible Magnetic Pick-Up Tool

- Capacity: 3.5Lbs
- L: 535mm



KA-6466 Pick Up Tool

- Bendable magnetic bar
Capacity: 3.5lbs
Length: 350mm
- Telescopic light magnetic pick-up tool



KA-6476 Magnetic Pick Up Tool

- Capacity: 3.5lbs
- Length: 210mm - 540mm(8.4" - 21.6")



2 IN 1 Light & Magnetic Pick Up Tool

- KA-6470** Length: 65 - 660mm
Capacity: 1.5LBS



- KA-6470A** Length: 180 - 650mm
Capacity: 5.5lbs



KA-6478 H/D 3-IN-1 Lighted Magnetic & Mirror

- L: 455mm
- Capacity: 3.5Lbs
- 25 x 25mm mirror



KA-3574 Crank LED Lighted Magnetic Flexible Pick-up Tool

- General power by cranking
- Crank charge function good for emergency and Environmental.
- Magnetic pick up (up to 1Kg)
- Overall length 600mm (24") with flexible shaft
- LED: 20000 MCD
- LI : 1.6V 40MA
- Material :
 - Handle : ABS
 - Flexible shaft : WIRE + Chrome Plated



LED for lighting
Magnet for pick up



Superb magnet
for attaching

KA-5153 Flexible Magnetic Flash Light

- Flexible shaft can reach to narrow and curved space.
- Replaceable LED bulb w/magnetic head
- Bright LED lights up the darkness by 3pcs LR44
- Strong magnetic bottom of the handle can attract on machine/cars.
- Many applications: auto, machinery, fishing, computer...
- Optional Accessories: clip / Ø32mm around inspection mirror



KA-6334 Ball-Pen/Flashlight

Multi-Purpose Light/Ball-Pen/Flashlight



KA-6477 9-IN-1 Handy Tool (space-shuttle)

- | | | |
|-------------------------|-----------------------|----------------------------|
| 1. Telescopic-Stick | 2. Torch | 3. Light Pen |
| 4. Water Cleaner Jet | 5. Carving Needle | 6. Water Spurting Adjuster |
| 7. Precision Philip Bit | 8. Precision Flat Bit | 9. Magnetic Body |



KA-2852 Pen Type UV Light

- 190mm
- Weight: 30 g
- Click On/ Off
- Pocket Clip

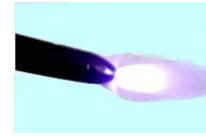

KA-2854 UV Flexible Light

- Total Length: 300mm
- Weight: 450g

KA-2855 UV Flexible Light

- Total Length: 400mm
- Weight: 460g

UV Flexible Light Set

Content:

- UV Flexible Light (300 or 400mm)
- KA-2853 UV Light Bulb OR KA-2862 LED Light Bulb
- Optic Fiber Light Guide (175mm- Optic Fiber Parts)
- KA-2863S Light Holder with Magnetic Base- Tight Grip, 67mm,35g



KA-2856 (with 300mm UV flexible light)

KA-2857 (with 400mm UV flexible light)



* Tight Grip & Strong Magnet, even upside down!!



* Use with Optic Light Guide



KA-5152 3 IN 1 ULTRA THIN LIGHT

- Good helper for repairing
- Good assistant for a maintenance man
- Invincible for a searcher

Is the all - in - one series product.

It can brighten in any area you want.

It can lighten anywhere even narrow corner.

It is the must for you to suit your need, and lighten the dark corner wherever you are

- Light bulb specifications.
 1. E10 : Philips bulb (2.25V x 0.25A)
 2. E5 : Krypton bulb (2.4V x 0.5A)
- 2. Fiber optic light guide (Ø 3 mm)



KA-2853 UV Light Bulb
KA-2862 LED Light Bulb



KA-2863F Optic Fiber Wand



KA-2863S CLOSE



KA-2863 LONG & OPEN

KA-2863S 67mm Light Holder W/Magnetic Base
KA-2863 82mm Long Light Holder W/Magnetic Base



KA-3865 LED Mini Flash Light

- 190 mm



KA-2867 LED Mini Flash Light (190 mm) SET

- 190mm
- KA-3865 LED Mini flashlight
- Optic light guide, light holder w/magnetic base



Magnetic LED Mini Flexible Flash Light

- KA-2870** L: 300 mm
- KA-3867** L: 400 mm



Flexible LED Flash Light Set

- Content:**
- 300mm or 400mm flexible LED flashlight
 - KA-2863S Light holder w/magnetic base

- KA-2868** (with 300mm flexible LED flash light)
- KA-2869** (with 400mm flexible LED flash light)



LED Mini Flexible Flash Light Set

- Content:**
- 300mm or 400mm LED Flexible Light
 - KA-2853 UV Light Bulb OR KA-2862 LED Light Bulb
 - Optic Fiber Light Guide (175mm- Optic Fiber Parts)
 - KA-2863S Light Holder with Magnetic Base
 - Tight Grip, 67mm, 35g

- KA-2864** (with 300mm LED flexible light)
- KA-2865** (with 400mm LED flexible light)

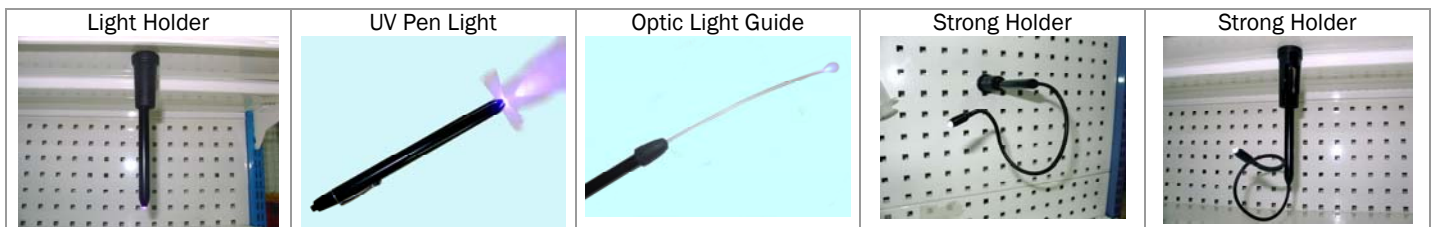



Magnetic LED Mini Flexible Flash Light

KA-2866 300mm
KA-3866 400mm

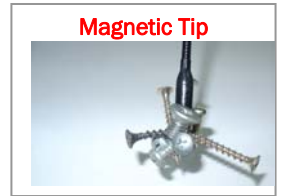

Magnetic LED Mini Flexible Light Set

Content:

- 300mm or 400mm Magnetic LED Mini Flexible Light
- KA-2863S Light Holder w/ Magnet Base

KA-2860 (with 300mm Magnetic LED Mini Flexible Light)
KA-2861 (with 400mm Magnetic LED Mini Flexible Light)

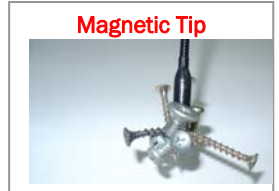

Magnetic LED Mini Flexible Light Set

Content:

- 300mm or 400mm LED Flexible Light w/ Magnetic Tip
- KA-2853 UV Light Bulb OR KA-2862 LED Light Bulb
- Optic Fiber Light Guide (175mm- Optic Fiber Parts)
- KA-2863S Light Holder with Magnetic Base- Tight Grip, 67mm, 35g

KA-2858 (with 300mm Magnetic LED Mini Flexible Light)
KA-2859 (with 400mm Magnetic LED Mini Flexible Light)

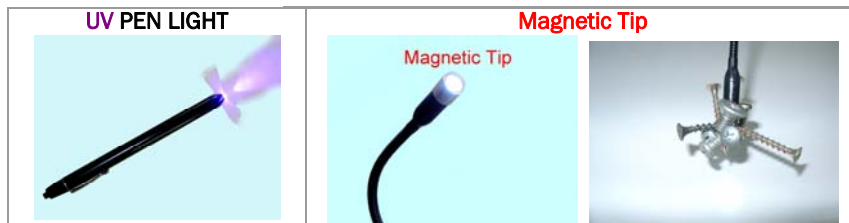

KA-3571 Mini Working Lamp Flexible & Magnetic

Combine 4 useful functions in 1unit

- LED Light
- Flexible Tube→ fix the angle accuracy
- Powerful Magnet→ retrieve items in tight areas
- Magnetic Stand→ attach firmly
- With 3pcs LR 41(1.5V) batteries





KA-EP222-6BX
6 Drawer Top Chest



KA-EP222-9BX
9 Drawer Top Chest



KA-EP333-6BX
6 Drawer Top Chest



KA-EP333-12BX
12 Drawer Top Chest

Item No.	Overall (W x D x H)	Drawers (W x D x H)		Steel Thickness	Packing (N.W./G.W./CUFT)
KA-EP222-6BX	660 x 307 x 374 mm	3 Drawers	170 x 275 x 50 mm	Body: 0.8mm Drawer: 0.7mm	23.9 / 26.9 / 3.97'
		2 Drawers	569 x 275 x 50 mm		
		1 Drawer	269 x 275 x 75 mm		
KA-EP222-9BX	660 x 307 x 427 mm	6 Drawers	170 x 275 x 50 mm	Body: 0.8mm Drawer: 0.7mm	28.4 / 32.4 / 4.3'
		2 Drawers	569 x 275 x 50 mm		
		1 Drawer	569 x 275 x 75 mm		
KA-EP333-6BX	660 x 455 x 483 mm	5 Drawers	576 x 410 x 48.5 mm	Top & bottom covers: 1.0mm Body: 1.2mm Drawer: 1.0mm	46.5 / 52.5 / 8.58'
		1 Drawer	576 x 410 x 75 mm		
KA-EP333-12BX	660 x 455 x 483 mm	9 Drawers	169 x 410 x 48.5 mm	Top & bottom covers: 1.0mm Body: 1.2mm Drawer: 1.0mm	55.5 / 59.2 / 8.58'
		2 Drawers	576 x 410 x 48.5 mm		
		1 Drawer	576 x 410 x 75mm		

* ball bearing slide on all drawers



KA-ET303
Trolley With 3 Drawers
Heavy Duty



KA-ET304
Trolley With 4 Drawers
Heavy Duty

Item No.	Overall (W x D x H)	Overall + Caster (W x D x H)	Drawers (W x D x H)		Steel Thickness	Packing (N.W./G.W./CUFT)
KA-ET303	764 x 490 x 754 mm	W/4" casters 764 x 490 x 884 mm	2 Drawers	298 x 445 x 81 mm	Cover: 1.8mm Body: 1.0mm Drawer: 1.0mm Pillar: 2.0mm	49 / 53.4 / 8.7'
			1 Drawer	2628 x 445 x 81 mm		
KA-ET304	764 x 490 x 890 mm	W/4" casters 764 x 490 x 1020 mm	2 Drawers	298 x 445 x 81 mm	Cover: 1.8mm Body: 1.0mm Drawer: 1.0mm Pillar: 2.0mm	60 / 65 / 10.82'
			1 Drawer	628 x 445 x 81 mm		
			1 Drawer	628 x 445 x 127 mm		

* ball bearing slide on all drawers



KA-W26-5X
5 Drawer Roll-Wagon



KA-W26-6XL
6 Drawer Roll-Wagon



KA-W26-7X
7 Drawer Roll-Wagon



KA-W26-8X
8 Drawer Roll-Wagon



KA-W26-10X
10 Drawer Roll-Wagon



KA-W53-13X
53" 13 Drawer Roll-Wagon
Fully shelf-Closing

Item No.	Overall (mm) (W x D x H)	Overall + Caster (mm) (W x D x H)	Drawers (W x D x H)		Steel Thickness	Packing (N.W./G.W./CUFT)				
KA-W26-5X	670 x 460 x 654	W/4" casters 670 x 460 x 777	3 Drawers	576 x 380 x 75 mm	Top & Bottom cover: 1.2mm Body: 1.0mm Drawer: 1.0mm	50.5 / 57.5 / 10.03'				
			1 Drawer	2628 x 445 x 81 mm						
KA-W26-6XL	670 x 460 x 812	W/5" casters 670 x 450 x 960	3 Drawers	576 x 380 x 75 mm		Top & Bottom cover: 1.2mm Body: 1.0mm Drawer: 1.0mm	62.7 / 70.7 / 12.24'			
			3 Drawers	576 x 380 x 154 mm						
KA-W26-7X	670 x 460 x 812	W/5" casters 670 x 460 x 960	5 Drawers	576 x 380 x 75 mm			Top & Bottom cover: 1.2mm Body: 1.0mm Drawer: 1.0mm	64 / 72 / 12.24'		
			2 Drawer	576 x 380 x 154 mm						
KA-W26-8X	670 x 460 x 812	W/5" casters 670 x 460 x 960	7 Drawers	576 x 380 x 75 mm				Top & Bottom cover: 1.2mm Body: 1.0mm Drawer: 1.0mm	66 / 74 / 12.24'	
			1 Drawer	576 x 380 x 154 mm						
KA-W26-10X	670 x 460 x 812	W/5" casters 670 x 460 x 960	6 Drawers	576 x 380 x 48.5 mm					Top & Bottom cover: 1.2mm Body: 1.0mm Drawer: 1.0mm	69 / 83.5 / 12.24'
			3 Drawers	576 x 380 x 75 mm						
			1 Drawer	576 x 380 x 154mm						
KA-W53-13X	1358 x 460 x 980	W/6" casters 1358 x 460 x 1150	10 Drawers	576 x 380 x 75 mm	Top & Bottom cover: 1.5mm Body: 1.2mm Drawer: 1.0mm					166 / 180 / 31.54'
			2 Drawers	576 x 380 x 154mm						
			1 Drawer	1215 x 380 x 173 mm						

* ball bearing slide on all drawers

Function:

- One piece steel of cabinet body provide more strength to whole one unit body structure.
- Hemmed edge for all drawers and body to add strength and safety.
- 100 numbers internal locking system for extra security.
- Quick release design on ball bearing slide can be easily removed for replacement.
- 100% open ball bearing slide.
- Patented locking system. Pushing unlocked drawer to be locked while all other are locked.
- Tool tray / side handle for easy lifting of roller wagon and can be holder for frequently used supplies.
- 2 fixed caster + swivel caster with brake.
- 2mm protective drawer liners.
- Powder coating finishing.
- Two fixture on two sides, can be attached and hung other equipment.
- Drawer are interchangeable.
- Additional patented design one drawer open at a time locking system and shelf-closing ball bearing slide at your option.
- Another drawer depth 410mm of W26 series for option.



KA-WB59A Workbench



KA-WB59B Workbench Plus 3 Drawer Chest
(KA-WB59A Plus 3 drawer chest)



KA-WB59C Workbench W/Backpanel



KA-WB59D Workbench W/ Backpanel Plus 3 Drawer Chest
(KA-WB59C Plus 3 drawer chest)



KA-WB59E Workbench W/Backpanel Plus 2 Wall Cabinets



KA-WB59F Combo Workbench Plus 2 Wall Cabinets
(KA-WB59E Plus 3 drawer chest and 2 wall cabinets)

	KA-WB59A	KA-WB59B	KA-WB59C	KA-WB59D	KA-WB59E	KA-WB59F
Overall (W x D x H) (mm)	1525 x 700 x 800	1525 x 700 x 800	1525 x 700 x 1520	1525 x 700 x 1520	1525 x 700 x 1520	1525 x 700 x 1520
Back panel Overall (W x D x H)	--	--	1525 x 20 x 700	1525 x 20 x 700	1525 x 20 x 500	1525 x 20 x 700
2 Wall Cabinet (W x D x H) (mm)	--	--	--	--	400 x 200 x 500	400 x 200 x 500
Drawer Chest Overall (W x D x H) (mm)	--	W/3 Drawer Chest 600 x 307 x 251	--	W/3 Drawer Chest 660 x 307 x 251	--	W/3 Drawer Chest 660 x 307 x 251
Drawers (W x D x H)	2 Drawers	569 x 275 x 50 mm	--	569 x 275 x 50 mm	--	569 x 275 x 50 mm
		569 x 275 x 75 mm		569 x 275 x 75 mm		569 x 275 x 75 mm
Steel Thickness (mm)	Workbench: 2.0 Pillar: 2.0	Workbench: 2.0 Drawer: 0.7 Pillar: 2.0	Workbench: 2.0 Drawer: 0.7 Backpanel: 1.0 Pillar: 2.0	Workbench: 2.0 Drawer: 0.7 Backpanel: 1.0 Pillar: 2.0	Workbench: 2.0 Wall cabinet: 1.0	Workbench: 2.0 Drawer: 0.7 Wall cabinet: 1.0 Backpanel: 1.0 Pillar: 2.0
Packing (N.W./G.W./CUFT)	48 / 49.5 / 6.5'	Box 1 of 2: 48 / 49.5 / 6.5'	59 / 62 / 6.5'	Box 1 of 2: 59 / 62 / 6.5'	Box 1 of 2: 59 / 62 / 6.5'	Box 1 of 2: 59 / 62 / 6.5'
		Box 2 of 2: 13 / 15.5 / 2.7'		Box 2 of 2: 13 / 15.5 / 2.7'	Box 2 of 2: 14 / 15.4 / 4.5'	Box 2 of 2: 32.2 / 35.2 / 8'

* ball bearing slide on all drawers



KA-EP213X 3 Drawers Portable Tool Chest

KA-EP213X	
Overall (W x D x H)	533 x 220 x 232.5 mm
Drawer Chest Overall (W x D x H)	504 x 195 x 51.5 mm
Steel Thickness	Body: 0.8mm Drawer: 0.7mm
Packing (N.W./G.W./CUFT)	11.2 / 11.9 / 2.05'



KA-T28 Three Shelf Trolley

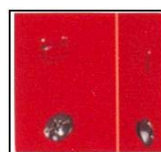

Insertion-plug structure adds much strength



KA-T28-1 One Drawer Trolley

- Two 3.5" deep trays are positioned for convenience.
- Bold pillar for extra strength
- Heavy-duty casters

Item No.	Overall (W x D x H)	Overall + Caster (W x D x H)	Drawers (W x D x H)		Steel Thickness	Packing (N.W./G.W./CUFT)
KA-T28	716 x 410 x 750 mm	W/4" casters 716 x 410 x 880 mm	--		Pillar: 2.0mm Shelf: 1.0mm	20.2 / 22.2 / 2.7'
KA-T28-1	716 x 410 x 750 mm	W/4" casters 764 x 490 x 1020 mm	1 Drawer	569 x 275 x 75 mm	Pillar: 2.0mm Shelf: 1.0mm Drawer: 0.7mm	23.2 / 24.6 / 2.75'

* ball bearing slide on all drawers

Storage Organizer

Assorted Case With Various Compartments

- Each compartment with belt clip for easy carrying.
- Optional divider for more storage options.
- Tough composite plastic compartment with selective configuration.
- Clear see-through design to identify contents at a glance.



Dimension:

- KT-09:(Small) 95x74x68mm
- KT-06:(Middle) 143x74x68mm
- KT-03:(Large) 295x74x68mm

* Tool not include



12PCS

KA-T612F



12PCS

KA-T369F



15PCS

KA-T9615F



18PCS

KA-T918F

Content	KA-T612F	KA-T369F	KA-T9615F	KA-T918F
KT-09	--	x 6 PCS	x 9 PCS	x 18 PCS
KT-06	x 12PCS	x 4 PCS	x 6 PCS	--
KT-03	--	x 2PCS	--	--



Optional:



P3C023138
Drill Bit Clip



P3C231009 Strap



P3C023145 Clapboard



16PCS

KA-T916L



11PCS

KA-T936L



12PCS

KA-T9612L

Content	KA-T916L	KA-T936L	KA-T9612L
KT-09	x 16PCS	x 7 PCS	x 4 PCS
KT-06	--	x 2 PCS	x 8PCS
KT-03	--	x 2PCS	--





Tools not included

KT-V0001 Tool Organizer

- Wall mounting type, for all kinds of hand tools
- Adjustable distance between two clips to fit all kind of tools.
- Anti-theft display card and screw box are included.
- Length of the aluminum bar: 438mm
- Overall length : 490mm
- Material: Back plate: ABS, Clip: Nylon 66
- Tools not included



Tools not included

KT-V0002 Screwdriver Organizer

- Wall mounting type, for screwdrivers
- 4 Clip diameter: 5mm, 7.5mm, 9.5mm , 12mm
- Clip the screwdriver horizontally or vertically.
- Anti-theft display card and screw box are included.
- Length of the aluminum bar: 438mm
- Overall length : 490mm
- Material: Back plate: ABS, Clip: Nylon 66
- Tools not included



Tools not included

KT-V0003 Wrench Organizer

- Wall mounting type, for wrench
- 3 hook sizes: 5mm, 7.5mm, 9.5mm , 12mm
- Anti-theft display card and screw box are included.
- Length of the aluminum bar: 438mm
- Overall length : 490mm
- Material: Back plate: ABS, Clip: Nylon 66
- Tools not included



Socket Organizer

KT-V0004 1/4"

KT-V0005 3/8"

KT-V0006 1/2"

- Wall mounting Type for Socket, Universal Joint, Extension bars, adapters, spark plug sockets.
- 3 stud sizes: 1/4", 3/8", 1/2"
- Anti-theft display card and screw box are included.
- Length of the aluminum bar: 438mm
- Overall length : 490mm
- Material: Back plate: ABS, Clip: pp



Tools not included





Tools not included

KA-2693 Magnetic Screwdriver Holder

- Two rows of holes for screwdrivers
- Holds 9 pcs screwdrivers
- Attached to any metallic surface.
- Rubber foot prevents damages or scratching to any surface.
- Size: 280mm (11")



Tools not included

Super Magnetic Tool Holder

- The magnetic tool holder have strong magnet.
- Option screws for wall-fixing.
- Material → Holder: ABS,
Magnet: Heavy Duty 1000 gauss permanent magnet.
Protective Covering: rough stainless steel cause not corrosion.

KA-2699 12" (300mm)

KA-2700 18" (450mm)



(Without Hook)



Tools not included

Magnetic Tool Holder

- Strong magnet designs to hold tools and parts firmly and securely.
- Organizes tools and keeps them visible and handy at any time
- Material: Holder-Plastic (ABS)
Protective covering-tough stainless steel will not corrode.
- Magnet: Magnet-heavy-duty 1000 gauss permanent magnet.
- Rubber: Protective rubber foot prevents from damage to valuable surfaces.

KA-2701 12" (300mm), with hook

KA-2702 24" (610mm), with hook

KA-2701N 12" (300mm), without hook

KA-2702N 24" (610mm), without hook



Tools not included

KA-2696 Magnet Tool Rack W/8pcs Hook

- Size: 310 mm (12.2") x 160 mm (6.3")
- 4 heavy duty magnets with durable rubber coating to prevent scuffing and scratching.
- 8- piece hooks and more than 177 square holes for easy arrangement.
- Attaching to any metallic surface.
- Organize tools easily .
- Capacity: 3 kg.



Tools not included

KA-2697 Magnet Tool Rack W/10pcs Hook

- Size: 450mm (17-3/4") x 228mm (9")
- 6 heavy duty magnets with durable rubber coating to prevent scuffing and scratching.
- 10- piece hooks and more than 78square holes for easy arrangement.
- Attaching to any metallic surface.
- Organize tools easily .
- Capacity: 6 kg.



Tools not included

KA-2698 Magnet Tool Rack W/15pcs Hook

- Size: 610 mm (24") x 152mm (6")
- 8 heavy duty magnets with durable rubber coating to prevent scuffing and scratching.
- 15- piece hooks and more than 87 square holes for easy arrangement.
- Attaching to any metallic surface.
- Organize tools easily .
- Capacity: 6 kg.

KT-V0011

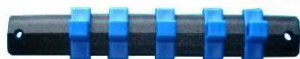

KT-V0012



KT-V0013



Plastic Socket Organizer

This socket organizer is an ideal solution at workshop to help user to organize sockets. Ergonomic handle bar is made of steel. The socket stud is made of PP.

- KT-V0011 150MM (Stud to be purchased separately)
- KT-V0012 200MM (Stud to be purchased separately)
- KT-V0013 250MM (Stud to be purchased separately)

Stud Available:

- KA-STUD-1/4 1/4" STUD
- KA-STUD-3/8 3/8" STUD
- KA-STUD-1/2 1/2" STUD

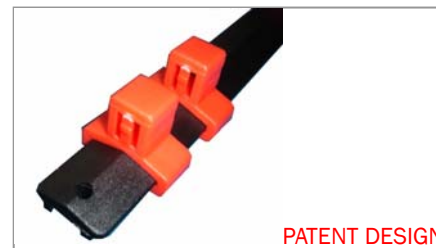

PATENT DESIGN

Magnetic Aluminum Socket Holder Rail

- Easy storage your socket and keep them in order.
- Spring loaded ball bearings on each clip hold socket firm and secure.
- Strong magnet holds tool organizer onto your tool box and won't scratch due to thin foam protection.



Size	Length: 300mm with 12pcs Socket Clip	Length: 457mm With 16pcs Socket Clip
1/4"	KT-V0016A	KT-V0016B
3/8"	KT-V0017A	KT-V0017B
1/2"	KT-V0018A	KT-V0018B

Magnetic Socket Holder

- Magnetic tray with special step-style arrangement.
- Accommodate about 16-piece with the socket size from 1/4" ~ 3/8" Dr.
- Magnetic socket holder prevent socket from falling.
- Strong magnetic attach to any metallic surface firmly.
- Material: Steel with Power coating to prevent rust and chipping.
- Size: 280mm * 90mm (11" * 3-1/2") (L x W)
- Capacity: 1000 g (2.5 Lbs)
- Weight: 600 g



KA-2694 (Straight)



KA-2695 (Taper)

- KA-2694 straight
- KA-2695 Taper



KA-2705T Magnetic T-Bar Holder

- Magnetic T-Bar holder is perfect for your working.
- The magnetic holder can accommodate more than 5 pieces T-Bars.
- Attach aside the tool cabinet and spare space. Bear up to 3kgs.
- Size: 6" (150mm) Length x 3-1/3"(85mm) Width
- Materials: Steel with powder coating
- Rubber: Protective rubber foot prevents damage to valuable surfaces.





Powerful Neodymium magnetic seats

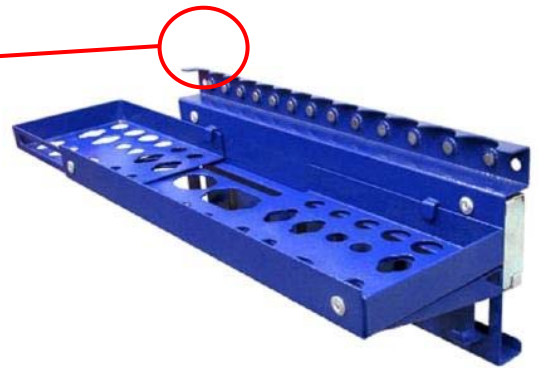

KA-2989 Multi-Function Magnetic Tool Holder

FUNCTION:

1. Organizes screwdrivers, sockets, wrenches, hammers, pliers and more in one place. (Hold up to 71 tools.)
2. Keep tools neat and in reach.
3. **Easily extend width to 50cm (20") for more available space.**
4. Our special magnets allow this patented design to carry up to 15 lbs by testing on 1mm thickness iron plate.
5. Perfect for using in garages, workshops, manufacturing sites and wherever you need it.
6. Removable and portable design can carry tools to anywhere you want at the same time.



Powerful Neodymium magnetic seats



KA-7818 Magnetic Table

FUNCTION:

1. Can use as an extra table anywhere you want.
2. Magnetic seats can attract small items (i.e. sockets, bits, screws...etc.)
3. Hooks for holding wrenches, hammers...etc.
4. Perfect for using in garages, workshops, manufacturing sites and wherever you need it.
5. Easy to take down notes, testing reports with table design.
6. Our special magnets allow this patented design to carry up to 15 lbs by testing on 1mm thickness iron plate
7. Removable and portable design can carry tools to anywhere you want at the same time.

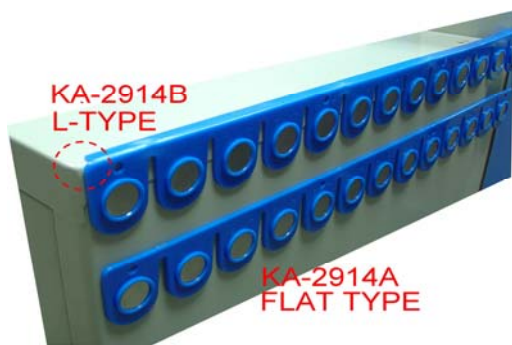

Tools not included

KA-2914A Single Magnetic Tool Holder

ONE 450mm, Strip W/13pcs Magnets

KA-2914B Magnetic Tool Holder

L - Type 450mm, Strip W/13pcs Magnets



KA-2703 Magnetic Glove/Tissue Dispenser Holder

- 4 powerful rubber covered magnets on the back of the glove/tissue dispenser
- Attaching onto any metallic surface
- 3 adjustable springs are designed to hold any sizes of glove/tissue boxes.
- Finished with power coating to prevent rust and chipping.
- Size: 254mm(10")H x 150mm(6")W x 95mm(3-3/4")D



Tools not included

KA-2704 Magnetic Glove/Tissue Dispenser Holder W/Side Tray & Screwdriver holder

- 4 powerful rubber covered magnets on the back of the glove/tissue dispenser
- Attaching onto any metallic surface
- 3 adjustable springs are designed to hold any sizes of glove/tissue boxes.
- Finished with power coating to prevent rust and chipping.
- Size of Glove/Tissue dispenser holder: 254mm(10")H x 150mm(6")W x 95"(3-3/4")D
- Size of Side Tray: 105mm(4-1/8") x 90mm (3-1/2") x 3-mm (1-1/4")
- Size of Screwdriver Holder: 76mm(3")L x 90mm (3-1/2")W x 30mm(1-1/4")D



KA-2705 Magnetic Air Impact Wrench & Socket Holder

- Professionally designed for placing impact wrench and sockets or any similar items.
- Capacity: 5 Kg
- This holder can be attached to any ferromagnetic metal surface such as Metal, Alloy containing iron, steel, cobalt and nickel.

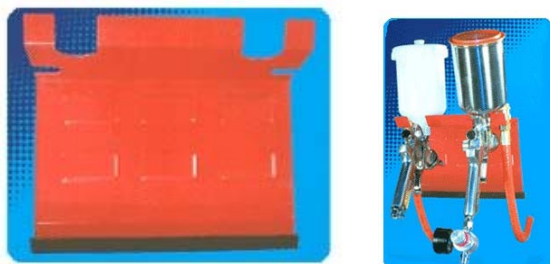

KA-2706 Magnetic Spray Gun/Hose Holder

- Powerful cushioned magnets and rubber bumper prevent surface damage
- Hole up to 2 gravity feed spray gun and d2 air hoses at the time.
- No more bending over to pick up hose.

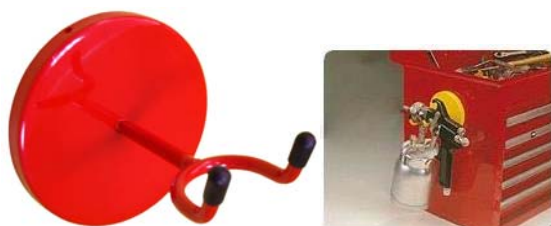

KA-2707 Y-Type Super Magnetic Hook

- A specially designed hook to hold air spray gun or any tool even clothes.
- Attaching to any ferromagnetic metal surface such as metal, alloy containing iron, steel, cobalt and nickel.
- Capacity: 1.5 kg
- Magnet: Heavy duty 2000 gauss permanent magnet (Diameter: 100mm(outer) x 30mm (inner) x thickness 12mm)
- Weight: 600g



KA-7660



KA-7660P

- High power magnet to hold the impact wrench & socket.
- Put on the tool chest or to pole lifter to hold the impact wrench.

KA-7660
Tool Hold With Two Magnetic Pad (Metal)

- Capacity: 15 kgs

KA-7660P
Tool Hold With Two Magnetic Pad (POLYA CETATE)

- Capacity: 21kgs



KA-7819 Magnetic Holder For Impact Wrench (iron + iron oxide)

CAPACITY: 15kgs

FUNCTION:

1. This magnetic holder is designed for holding most pistol type impact wrenches and impact sockets.
2. Special magnetic structure can firmly attach to ferric surface up to 15 lbs.
3. The magnetic holder can easily hold one impact wrench, four impact sockets, and other tools, like screwdrivers.
4. With PE coating finishing, this magnetic holder is environmental compliance.
5. Screw-holes design, you can screw the holder on nonferrous surface (two screws included).
6. Wire hook for organize air hoses or electric wire.



KA-2871 Simple Magnetic Impact Wrench Holder

- Capacity: 2.7 kgs



KA-7660S All Plastic Magnetic Impact Wrench Holder

- Capacity: 8.1kgs



KA-7660A Side View Mirror Holder

- Spray and dry odd-shaped trim and wing mirrors quickly and easily.
- Fix trim to spray-aid and hand-hold to spray.
- Then fix to wall in spray-booth to dry using two strong magnets.

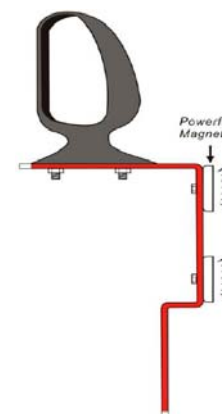



KA-5225-T Magnetic Round Dish With Tray

- Tray: diameter 150mm (6") x 30mm
- Stainless steel dish with plastic tray
- Magnetic field intensity: 1000~2000 gauss
- Magnetic metal dish for metal parts, and non- conductive tray for metal-less small parts.

Material:

- Tray: stainless steel
- Pad: Rubber
- Magnet: Permanent magnet
- Saucer: ABS



KA-5224-T Magnetic Rectangular Dish With Tray

- 240 mm X 143mm
- Stainless steel dish with plastic tray
- Magnetic metal tray for metal parts, and non- conductive tray for metal-less small parts.



KA-2589B Magnetic Bowl For Parts

- Plastic part bowl with magnet is excellent for storing or holding the easy-to-lose small parts.
- Great for garage work, engine work, household work...etc.
- Strong magnetic base is covered with rubber.
- Magnetic base is oil-resistant.
- Diameter: Φ 6" (150mm)



Vertical Magnetic Tool Tray

- Made of cold roll steel 0.80mm thickness.
- Protective rubber foot causes no damage on any surface.
- Special magnetic tray can be attached onto any metallic surface such as tool trolley or tool chest.
- An excellent helper for auto repairing or household works.
- Powder coating surface to prevent rust and chipping.



Item no.	SIZE (L x W x Depth)	CAPACITY
KA-2686T	150mm x 115mm x 31mm	800g
KA-2687T	190mm x 115mm x 31mm	1500g
KA-2688T	210mm x 115mm x 31mm	2000g
KA-2689T	240mm x 115mm x 31mm	2500g
KA-2690T	270mm x 115mm x 31mm	3000g
KA-2691T	310mm x 115mm x 31mm	3500g

KA-2692T Magnetic Two Way Tool Tray

- Made of cold roll steel 0.80mm thickness.
- Protective rubber foot causes no damage on any surface.
- Special magnetic tray can be attached onto any metallic surface such as tool trolley or tool chest.
- An excellent helper for auto repairing or household works.
- Powder coating surface to prevent rust and chipping.
- Special design for storing screwdriver.
- Size: 310mm X 115mm [12-1/5"(L) ~ 4-1/2" (W)]
- Capacity: 4000g (8.1 Lbs)
- Weight:950g





KA-2883 Round Plastic Magnetic Tray – Ø150mm (5-3/4")

- Packing: sliding card
- 30sets/ctn; 11/12kgs/1.7'



KA-2884 Magnetic Bowl & Rack

- Material of black area : PP
- Round plate : Stainless Steel
- Packing : color box
- 12set/ctn; 15.8/16.8kgs/1.8'



KA-2885 Magnetic Tool Holder

- Size : 305*50*7mm
- Packing : sliding card
- 12/inner/24/ctn; 15.5/16.5kgs/0.6'



KA-6332 Watch Type Magnetic Tray

W/4pcs Bits

When repairing parts, you can use this magnetic tray, help your working



KA-6220A



KA-6210A

Magnetic Tray

- Material: Stainless steel

KA-6220A size: 330 x 250 x 25mm

KA-6210A size: 240 x 140 x 30mm



KA-2091A / KA-2091B



KA-2091C

* Tool not includes.



Retractable Magnetic Parts Tray KA-2091A KA-2091B KA-2091C

- With magnetic base for securing any metal parts.
- Holds bolts, nuts, nails and other small metal or non-metal objects.
- Can be used horizontally, vertically, upside down or hang on hook.
- Retractable design for easy to store in narrow space, such as tool bag, tool drawer...etc.

	KA-2091A	KA-2091B	KA-2091C
Top Ø	8-5/8" (225mm)	5-1/4" (134mm)	11-5/16" x 7-7/8" (278 x 200mm)
Bottom Ø	3-3/8" (86mm)	2" (51mm)	7-5/16" x 3-3/8" (185 x 85mm)
Max. Depth	5" (127mm)	3-1/2" (90mm)	2-3/4" (70mm)
Min. Depth	1-3/4" (43mm)	1-1/4" (31mm)	1-3/8" (36mm)
Folds	4	4	3
N.W.	14.8 oz (419g)	4.2 oz (120g)	22.2 oz (630g)
Shape	Round (large)	Round (small)	Oval



KA-3798 Magnetic Clamp

- Powerful magnetic base – holds up to 5 lbs.
- Hands free for controlled spray painting.



KA-3798A Magnetic Base Paint Clamp

- Flexible shaft for controlled spray painting.
- Powerful magnetic base.
- Hands free for use on metal paint booth walls.



KA-3798B Soldering And Assembly Clamp

- Offers an extra pair of hands when soldering or assembling.
- Flexible design allows work to be held in a variety of positions.
- Magnetic base attaches to any ferrous surface.
- Hex shaped base allows use in a vise when required.





Plastic Wrench Rack

- Hold up wrench for easy size identification
- Can also hang on a wall or carry to job.

Item No.	Slot	Type
KA-1379-12	12 pcs	Forward
KA-1379-15	15 pcs	Forward
KA-1379-12RV	12 pcs	Reverse



Stubby Wrench Rack

- Made from tough TPR plastic.
- Can also be hang on a wall or carry to job.
- Suitable for stubby wrench

Item No.	Slot
KA-1378-5	5 pcs
KA-1378-6	6 pcs
KA-1378-7	7 pcs
KA-1378-8	8 pcs
KA-1378-11	11 pcs
KA-1378-12	12 pcs



TPR Wrench Rack

- Made from tough TPR plastic
- Can also be hang on a wall or carry to job.
- Suitable for combination, geared, ring, open end and flare nut spanners.

Item No.	Slot	Type
KA-1382	8 pcs	Forward
KA-1382-12	12 pcs	Forward
KA-1382-15	15 pcs	Forward
KA-1382-RV	8 pcs	Reverse
KA-1382-12RV	12 pcs	Reverse
KA-1382-15RV	15 pcs	Reverse



KA-1379 4pcs Magnetic Sharks Teeth Wrench Rack

- Durable composite sharks teeth spanner rack with magnetic strips, helps to maintain an organized topchest / rollcab.
- Easy to storage the wrenches, make them in order.
- Suitable for combination wrench, double end wrench, double open wrench and so on.
- Material: PP
- Content:
2pcs - Forward type.
2pcs - Reverse type

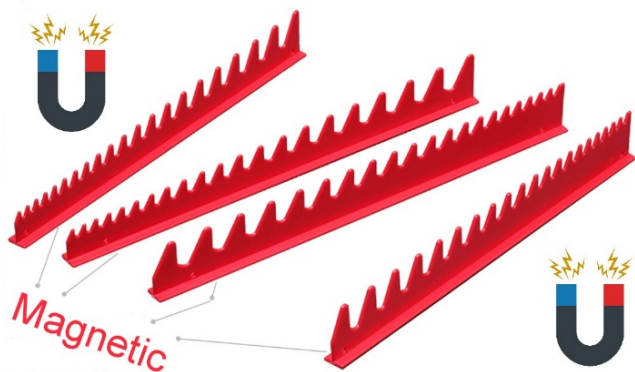

KA-1380 16 Slot Reversible Wrench Rack

- Material: ABS, PP
- Take up 30% more storage space.

*** Rail Detachable ***



KA-1376 Metal Socket Tray Rack - 40pcs

- Organized classification sockets specification and placement.
- The surface uses a better texture power coating.
- With handle function, easy to carry tools to the workplace.
- The thin design of the socket tray can be placed in a low-height drawer of tool car or hanging on the wall

Capacity:

Hold up to 10pcs 1/4"DR. socket
Hold up to 20pcs 3/8"DR. socket
Hold up to 10pcs 1/2"DR. socket



KA-1377 Metal Socket Tray Rack - 80pcs

- Organized classification sockets specification and placement.
- The surface uses a better texture power coating.
- With handle function, easy to carry tools to the workplace.
- The thin design of the socket tray can be placed in a low-height drawer of tool car or hanging on the wall

Capacity:

Hold up to 20pcs 1/4"DR. socket
Hold up to 30pcs 3/8"DR. socket
Hold up to 30pcs 1/2"DR. socket





3/8" Metal Socket Rail – Compact Type

- Mini Type/Easy to handle
- Keep the sockets in neat order.

	Stud	Size
KA-1400-S3808	8	3/8" x 185mm (L)
KA-1400-S3810	10	3/8" x 260mm (L)
KA-1400-S3812	12	3/8" x 300mm (L)

Ductile Iron Bench Vise

Features:

- Ten year warranty
- Industrial-level bench vise
- 360° Swivel base
- Made of FCD 45 spheroidal graphite iron castings
- Precise with strong clamping force
- Hardness of vise jaw HRC 25° ~ HRC 30°
- Equipped with anvil
- Finished with back paint



Specifications

Model	size	Packing	Jaw opening	Throat depth	N.W. (kg)	G.W. (kg)	CUFT
KCT-101-4	4"	1PC/CTN	4"	2-5/8"	12.2	12.7	0.43'
KCT-101-5	5"	1PC/CTN	5"	3-1/4"	16	16.7	0.6'
KCT-101-6	6"	1PC/CTN	6"	3-3//4"	21.5	22.4	0.82'
KCT-101-8	8"	1PC/CTN	8"	4"	29.2	30.2	0.97'

All Cast Steel Bench Vise

Features:

- Ten year warranty
- Industrial-level bench vise
- 360° Swivel base
- Made of SC37 cast carbon steel
- Equipped with anvil and pipe jaw
- Hardness of vise jaw HRC 25° ~ HRC 30°
- Finished with back paint



Specifications

Model	size	Packing	Jaw opening	Throat depth	N.W. (kg)	G.W. (kg)	CUFT
KCT-102-3	3"	1PC/CTN	3"	2"	4.5	6	0.2'
KCT-102-4	4"	1PC/CTN	4"	2-1/4"	7.5	8.3	0.4'
KCT-102-5	5"	1PC/CTN	5"	2-5/8"	11	12	0.6'
KCT-102-6	6"	1PC/CTN	6"	3"	14.5	16	0.8'
KCT-102-8	8"	1PC/CTN	8"	3-1/2"	20.5	22	1.2'
KCT-102-10	10"	1PC/CTN	10"	4"	25.6	28	1.5'

K-Type Machine Vise

Specifications



Model	size	Packing	Jaw opening	Throat depth	N.W. (kg)	G.W. (kg)	CUFT
KCT-103-4	4"	1PC/CTN	4"	1-3/16"	9	10	0.24'
KCT-103-6	6"	1PC/CTN	6"	1-9/16"	25	26	0.97'
KCT-103-8	8"	1PC/CTN	8"	2-1/4"	57	60	2.4'

Precision Angle Lock Machine Vise

Specifications



Model	size	Packing	Jaw opening	Throat depth	N.W. (kg)	G.W. (kg)	CUFT
KCT-104-4	4"	1PC/CTN	4"	1-3/16"	19	20	0.47'
KCT-104-6	6"	1PC/CTN	6"	1-9/16"	40	41	15'
KCT-104-8	8"	1PC/CTN	8"	1-15/16"	76	80	2.9'



Home Vise

Features:

- Made of FC25 iron castings
- 260° Swivel base
- Equipped with anvil or pipe jaw

Specifications

Model	size	Packing	Jaw opening	Throat depth	N.W. (kg)	G.W. (kg)	CUFT
KCT-105-312	3-1/2"	6PC/CTN	3-1/2"	2"	28	30	1.1'
KCT-105-4	4"	2PC/CTN	4"	2"	9.6	10	0.4'



Clamp-on Vise

Features:

- Made of FC iron castings and can be fixed on the desk
- Made of Aluminum alloy and can be fixed on the desk

Specifications

Model	size	Packing	Jaw opening	N.W. (kg)	G.W. (kg)	CUFT
KCT-106-3	3"	10(36)PC/CTN	2"	9	9.5	1.2'
KCT-106-3A (aluminum)	3"	36PC/CTN	2"	16	17	3'



Table Vise With Suction Base

Features:

- Made of aluminum alloy castings
- A sucker base attached
- Structured with a spherical body for angle changes

Specifications

Model	size	Packing	Jaw opening	N.W. (kg)	G.W. (kg)	CUFT
KCT-109-3	3"	4PC/CTN	2-12"	4	5	0.5'

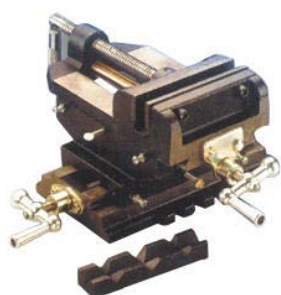

Drill Press Cross Vise

Specifications

Model	size	Packing	Jaw opening	Longitudinal Travel	N.W. (kg)	G.W. (kg)	CUFT
KCT-111-3	3"	1PC/CTN	2-3/4"	5"	6.2	7	0.31'
KCT-111-4	4"	1PC/CTN	3-3/4"	6"	10	11	0.44'
KCT-111-5	5"	1PC/CTN	4-3/4"	7"	13.5	15	0.5'
KCT-111-6	6"	1PC/CTN	5-3/4"	8"	16.5	18	0.65'
KCT-111-8	8"	1PC/CTN	7-3/4"	10"	30	32	1.2'



All Steel Bench Vise

Features:

- KCT-201 Made of 100% steel
- No concern of body breakage
- Vise jaw is thermal treated with hardness of HRC C25° ~ HRC30°
- 360° Swivel base

Specifications

Model	size	Packing	Jaw opening	Throat Depth	N.W. (kg)	G.W. (kg)	CUFT
KCT-201	6"	1PC/CTN	7"	2-5/8"	12	13	0.8'

Forged Bench Vise

Features:

- Made of 100% steel plate
- High Clamping force
- No concern of breakage within 10 years
- Equipped with pipe jaw and anvil
- 360° Swivel base
- Vise jaw is thermal treated with hardness of HRC C25° ~ HRC30°



Specifications

Model	size	Packing	Jaw opening	N.W. (kg)	G.W. (kg)	CUFT
KCT-202-4	4"	1PC/CTN	4"	4.5	5	0.3'
KCT-202-5	5"	1PC/CTN	5"	5.7	6.2	0.4'
KCT-202-6	6"	1PC/CTN	6"	12.8	13.5	0.6'
KCT-202-7	7"	1PC/CTN	7"	26.8	28	1.2'

Drill Press Vise

Specifications



Model	size	Packing	Jaw opening	Throat Depth	N.W. (kg)	G.W. (kg)	CUFT
KCT-203-3	3"	8PC/CTN	2-3/4"	3/4"	16	18	0.75'
KCT-203-4	4"	6PC/CTN	4"	1"	18	20	0.79'
KCT-203-5	5"	4PC/CTN	5"	1"	20	22	0.71'
KCT-203-6	6"	3PC/CTN	5-1/2"	1"	19.2	21	0.62'

Reed Bench Vise

Features:

- Made of FC25 gray iron castings
- Precise with high clamping force



Specifications

Model	size	Packing	Jaw opening	N.W. (kg)	G.W. (kg)	CUFT
KCT-401-4	4"	1PC/CTN	4"	13.4	14.2	0.65'
KCT-401-5	5"	1PC/CTN	5"	17.4	18.1	0.78'
KCT-401-6	6"	1PC/CTN	6"	24.8	25.6	1.18'

Gray Iron Casting Bench Vise

Features:

- Made of FC25 gray iron castings
- 360° Swivel base
- Equipped with anvil



Specifications

Model	size	Packing	Jaw opening	Throat Depth	N.W. (kg)	G.W. (kg)	CUFT
KCT-501-4	4"	4PC/CTN	4"	2-3/8"	13.4	14.2	0.65'
KCT-501-5	5"	2PC/CTN	5"	2-3/4"	17.4	18.1	0.78'
KCT-501-6	6"	1PC/CTN	6"	3-1/8"	24.8	25.6	1.18'

KA-MJ300 Micro-Jet

- powered by normal disposable/ refillable lighter
- Instant 1300°C/2400°F micro torch flame
- Auto-ignition
- Pocket size



Specifications:

Outer body measure	(H) 110mm x (W) 65mm x (L) 25mm
Weight	60 g
Fuel	RC-30 refill cartridge, disposable lighter or similar product except child proof's
Hours of use	Approx. 20 minutes per disposable lighter
Flame temperature	1300°C blue flame

Features:

- Piezo electronic ignition system-with safety lock.
- Power by RC-30 refill cartridge or disposable gas lighter. Inexpensive and readily available.
- Flame temperature up to 1300°C (2500°F)
- Wind-Proof flame and waterproof ignition make the Micro-Jet ideal for camping and outdoor use.
- Compact size allows the unit to fit easily into any first aid/survival kit or tool kit.

How to use:

- Remove the upper body, then place the disposable gas lighter into the main body. Then, slide the two halves of the body back together. (refer to the figure)
- Switch the safety lock to the unlocked position. Then, slowly press the ignition button to the maximum point. Your MICRO-JET is now fired up and ready to use. (Note: if no flame appears, adjust the regulator on the disposable lighter and press the ignition button again.) As the gas in the lighter is consumed, the regulator will need to be adjusted periodically to ensure a proper flame.
- When the ignition button is released, there will be a short delay before the flame is completely extinguished.
- When the MICRO-JET is not use, remove the disposable gas lighter. (Or refill cartridge)

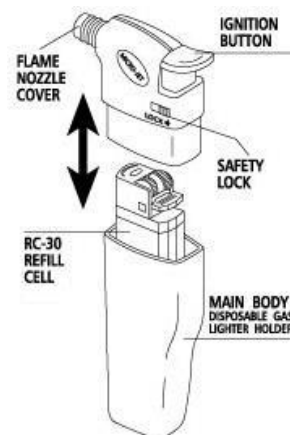

Warnings:

- Read instructions before use.
- Only use our RC-30 refill cartridge, disposable gas lighter or similar product.
- Do not ignite or use near an open flame, heater, furnace, or combustible material.
- Do not touch the nozzle cover during use, or before sufficient time has passed for cooling.
- Always be sure the unit is cool, and the lighter removed, before storing.
- Store properly when not in use, switch the safety lock to the locked position, keep in a dry place, out of the reach of children.
- Do not attempt to readjust or repair. The MICRO-JET unit is not user serviceable.
- Do not use continuously for more than five (5) minutes.

Caution: The torch flame is almost invisible in daylight, or in strong light.

KA-PT200 Pro-Torch

- Butane Powered
- Child resistant automatic ignition system

The KA-PT200 Pro-Torch features an adjustable high BTU output flame. The body, constructed of hi-tech polymers provides a sturdy yet lightweight feel and the internal brass and ceramic parts ensure precision operation and long life. Use this affordable tool in the shop, lab, kitchen, garage or wherever a reliable butane torch is required.



* Colors: black, red, yellow, blue *

Specifications:

Dimension	H	139mm (5.5")
	L	101mm (4.0")
	Grip Dia	34mm (1.34")
	Base	61mm (2.4")
Weight (w/o fuel)	145g (empty)	
Fuel	Butane	
Torch	1300°C (2400°F)	
Hours of nonstop burning	60 minutes (mid. setting)	
Gas container capacity	20 ml	
Flame Temperature	1300°C (blue flame)	



Features:

- State of the art waterproof piezo electronic ignition system. Up to 90 minutes use on each filling. Powerful wind-resistant flame.
- Compact size with ergonomic grip.
- Child-resistant ignition for safety.
- Easily refilled with any brand of butane gas.
- Flame adjustment for any size job.

Instructions:

- A. Prior to initial use, fill torch with butane fuel as described below.
- B. To fill gas tank, turn unit upside down and firmly push the butane can nozzle into the filling valve (fig.D)
- C. To ignite the torch:
 1. Slide the gas regulator lever to the "ON" position (fig.A)
 2. Rotate the igniter button slightly to the left (counterclockwise) to release the childproof lock (fig.B)
 3. The flame can then be adjusted by sliding the regulator lever.
- D. To shut off the torch, simply move the regulator lever to the far left and until you feel or hear it click into the lock-off position.

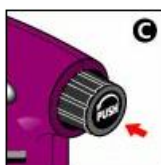
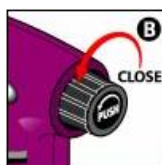
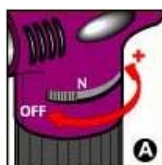

Warnings:

- Do not touch flame guard while in use or until sufficient time has passed for cooling.
- Do not immerse heated parts or items in water, allow to cool naturally.
- Use only butane gas in the torch. Do not use propane gas or any other types of fluids.
- Do not store in a temperature exceeding 40°C / 104°F
- Keep away from eyes at all times.
- Keep this unit out of the reach of children.
- The flame of the torch is nearly invisible in bright light or sunlight.
- Make sure that gas flow is turned off when not in use.



KA-PT500 Pro-Torch

- Heavy duty, stable flame, ergonomic grip

The heavy duty KA-PT500 provides the most powerful and stable butane flame available for demanding jobs where the highest BTU output is required. Its precision orifice and controls offer the best there is in a high output butane tool.

The ergonomic grip makes using the KA-PT500 comfortable at most any angle.

KA-PT500 was designed with features to withstand the rigors of daily professional use.



* Colors: black, red, yellow, blue *

Specifications:

Dimension	H	177mm (7.0")
	L	120mm (4.73")
	Grip Dia	45mm (1.78")
	Base	65mm (2.56")
Weight (w/o fuel)		460g (empty)
Fuel		Butane
Torch		1350°C (2500°F)
Hours of nons op burning		200 minutes (mid. setting)
Gas container capacity		60 ml
Flame Temperature		1350°C (blue flame)



Features:

- State of the art waterproof piezo electronic ignition system.
- Large fuel tank for 200 minutes use on each filling.
- Powerful high output wind-resistant flame.
- Ergonomic designed comfortable grip.
- Angled nozzle to properly direct flame.
- Easily refilled with any brand of butane gas.
- Flame adjustment for the most demanding applications.

Instructions:

- Prior to initial use, fill torch with butane fuel as described below.
- To fill gas tank, turn unit upside down and firmly push the butane can nozzle into the filling valve (fig.C)
The tank should be filled in approximately ten seconds.
Please allow a few minutes after filling for the gas to stabilize.
- To ignite the torch:
 1. Rotate the gas control knob counterclockwise(left) till hear the gas flow sound.
 2. Depress the igniter button (fig.B) to ignite.
 3. The flame size can then be adjusted by rotating the gas control knob (fig.A) in either direction.
 4. The flame temperature may be adjusted by rotating the Air control ring.
- To shut off the torch, simply rotate the gas control knob fully clockwise (right.).

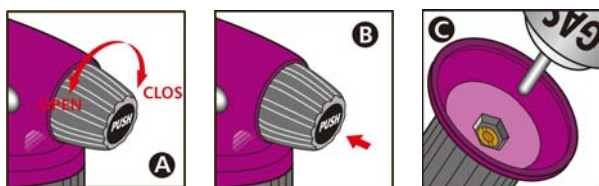

Warnings:

- Do not touch flame guard while in use or until sufficient time has passed for cooling.
- Do not immerse heated parts or items in water, allow to cool naturally.
- Use only butane gas in the torch. Do not use propane gas or any other types of fluids.
- Do not store in a temperature exceeding 40°C / 104°F
- Keep away from eyes at all times.
- Keep this unit out of the reach of children.
- The flame of the torch is nearly invisible in bright light or sunlight.
- Make sure that gas flow is turned off when not in use.

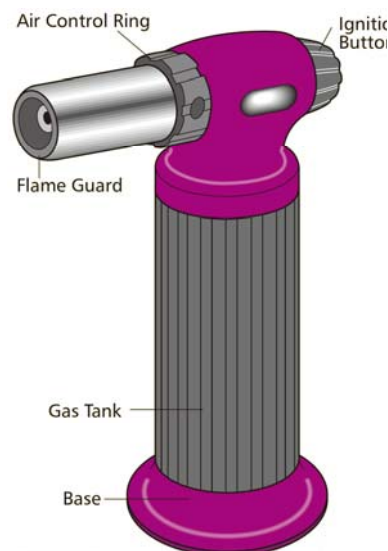



KA-PRO120

Soldering Iron Kit

KA-PRO120 KA-PRO120K

- Power range: 30W ~ 125W
- Automatic igniting
- Portable model, multi-function heat tool
- Butane Powered
- Bold ergonomic design

Features:

- Equivalent to a power range 30-125watt.
- Cordless, simple, safe operation anywhere.
- Ready to use 15 seconds after ignition.
- Tank contains fuel for 120 minutes of operation.
- No cords, can be used anywhere.
- No electrical interference.
- Comes with soldering tip and protective cap.

Specifications:

Length:	w/cap	254mm (10")
	w/soldering tip	245mm (9.7")
Weight(when gas-filled)		166g
Approximate temperature soldering tip		250~550°C (480~1000°F)
Torch		1300°C (2400°F)
Gas container capacity		12 ml
Operating Time (one gas filling)		100 min At mid setting



KA-PRO120K

(contents: KA-PRO120, Solder, Sponge, PS-14, PS-9, PS-10, PS-3)

Applications:

Automotive and truck repairs, Aviation service and repair, Electrical components, Environmental splicing, Field repairs, Insulated solder preform, Jewelry repair, Loosen rusted nuts and bolts, Maintain switch panels, Repair television sets, meters, switch boards, sensitive IC boards, shrink tubing, silver solder, soften window caulking, Solder circuit boards, TV cable systems, Weld plastics.

Option accessories: the accessories listed below are available

Parts NO.	Description	Type
PS-1	1.6mm soldering tip	Conical
PS-2	3.2mm soldering tip	Conical
PS-3	2.4mm soldering tip * KA-PRO120K includes	Chisel
PS-4	3.2mm soldering tip	Chisel
PS-5	2.4mm soldering tip	Angle

Parts NO.	Description	Type
PS-6	3.2mm Soldering tip	Angle
PS-9	Hot Knife * KA-PRO120K includes	--
PS-10	Heat Blower * KA-PRO120K includes	--
PS-14	Orifice Assembly * KA-PRO120K includes	--
S-30	Defleclor	--

How to changing tips:

1. Be sure the tip has cooled before removal.
2. The catalyst seen through the hot air exhaust hole of the soldering tip is very delicate and will not sustain mechanical abuse without serious damage.
3. The soldering tip is easily removable allowing the installation of other style tips or the replacement of a worn tip. After the soldering tip is cool, simply unscrew it with a counterclockwise motion. Be careful not to over-tighten as this could damage the nozzle assembly and thread in the body.

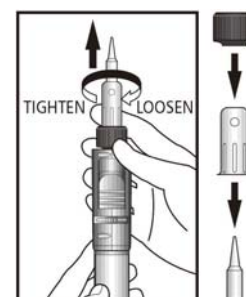



KA-PRO150



KA-PRO150KB

(contents: KA-PRO150, Solder, Sponge, PS-14, S-30, PS-10, PS-4, LEC (liquid energy cell))

Soldering Iron Kit

KA-PRO150 KA-PRO150KB

- Power range: 30W ~ 125W
- Automatic igniting
- Portable model, multi-function heat tool
- Butane powered with removable refillable LEC (liquid energy cell)

Features:

- Equivalent to a power range 30-125watt.
- Cordless, simple, safe operation anywhere.
- Ready to use 15 seconds after ignition.
- Patented LEC removable fuel cell for uninterrupted use, safety & reliability even at very low temperatures. LEC refills easily with any brand of butane fuel. LEC filters butane for no-clog operation.
- Disposable LECs available. Integrated stand for safety and hands free use.
- May be legally transported on commercial airlines (without LEC)
- No electrical interference.
- Comes with soldering tip and protective cap.

Specifications:

Length:	w/cap	254mm (10")
	w/soldering tip	245mm (9.7")
Weight(when gas-filled)		240g
Approximate temperature soldering tip		250~550°C (480~1000°F)
Torch		1300°C (2400°F)
Gas container capacity		20 ml
Operating Time (one gas filling)		30 min At mid setting

Applications:

Automotive and truck repairs, Aviation service and repair, Electrical components, Environmental splicing, Field repairs, Jewelry repair, Loosen rusted nuts and bolts, Maintain switch panels, Repair television sets, meters, switch boards, sensitive IC boards, shrink tubing, silver solder, soften window caulking, Solder circuit boards, TV cable systems

Option accessories: the accessories listed below are available

Parts NO.	Description	Type
PS-1	1.6mm soldering tip	Conical
PS-2	3.2mm soldering tip	Conical
PS-3	2.4mm soldering tip	Chisel
PS-4	3.2mm soldering tip * KA-PRO150KB includes	Chisel
PS-5	2.4mm soldering tip	Angle

Parts NO.	Description	Type
PS-6	3.2mm Soldering tip	Angle
PS-9	Hot Knife	--
PS-10	Heat Blower * KA-PRO150KB includes	--
PS-14	Orifice Assembly * KA-PRO150KB includes	--
S-30	Defleclor * KA-PRO150KB includes	--

How to changing tips:

1. Be sure the tip has cooled before removal.
2. The catalyst seen through the hot air exhaust hole of the soldering tip is very delicate and will not sustain mechanical abuse without serious damage.
3. The soldering tip is easily removable allowing the installation of other style tips or the replacement of a worn tip. After the soldering tip is cool, simply unscrew it with a counterclockwise motion. Be careful not to over-tighten as this could damage the nozzle assembly and thread in the body.

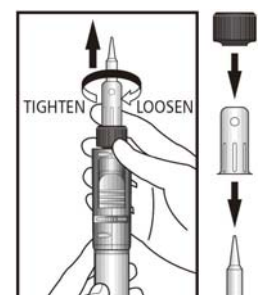



KA-PT600A PRO-Torch

- Automatic ignition propane
- Powered pro-torch

The heavy duty KA-PT600A type provides the most powerful and stable propane flame available for demanding jobs where the highest BTU output is required. Its precision orifice and controls offer the best there is in a high output propane tool. The rotating hand protection plate makes using the KA-PT600A comfortable at most any angle.

KA-PT600A was designed with features to withstand the rigors of daily professional use.

Features:

- Powerful wind-resistant flame.
- Patented rotating hand protection plate for safe use at any angle.
- High output flame for plumbing and other heavy duty jobs at home and in the workplace.
- Use safely at any angle.

Specifications:

	H(w/o stand)	138mm (5.4")
Dimension	L	100mm (3.9")
	W	36mm (1.4")
	Weight (when gas-filled)	280 g
Torch		1300°C (2400°F)
Gas container capacity		60 ml
Operation capacity (one gas filling)		120min. At mid setting

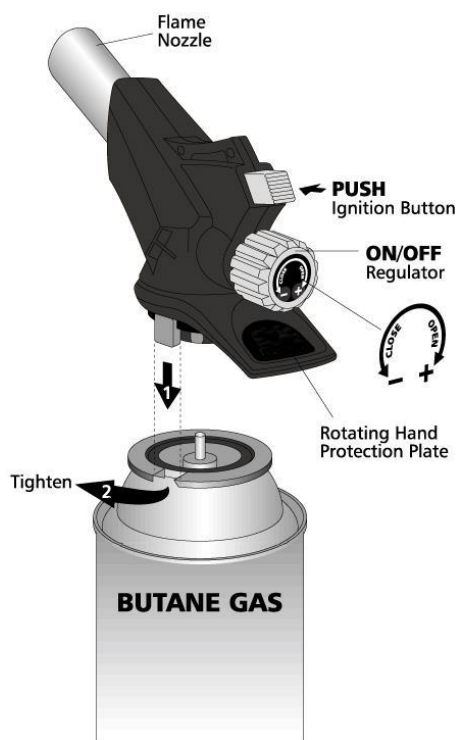

Applications:

Brazing, soldering, plumbing, BBQ grill charcoal starter, tool and die shops, automotive and truck repairs, industrial maintenance

Instructions:

- Connect KA-PT600A to Butane Canister by pushing down and turning clockwise (right) until it stops. Be sure to align butane output valve with torch input valve.
- To ignite, turn regulator knob counterclockwise (left) approximately 1/4 turn to start the gas flow and then push ignition Button. You may have to push ignition button more than once depending on conditions.
- Rotate regulator knob to the LEFT for higher flame or to the RIGHT for lower flame.
- If using the torch upside down, the flame may continue to burn for 10 seconds after turning off gas.
- When replacing or disconnecting the butane canister, make sure that the regulator knob is tight in the OFF (right) position to avoid leaking.
- Disconnect torch from cylinder when not in use.
- Within 2 minutes of ignition, the flame may appear red. During this time the torch should only be used in an upright position. After 2 minutes of preheating the torch may be rotated to any angle.

Warning:

- Only use the torch in a well-ventilated area.
- Carefully follow the instructions and warnings and familiarize yourself with the torch before use. Failure to follow these instructions could cause property damage, personal injury or death.
- Be aware that the tip of the torch can get extremely hot during or after use. Keep the torch away from children. Do not touch the torch nozzle after use.
- Never connect to a fuel cylinder near any flammable materials, chemicals, liquids or gases.
- Always point the torch flame away from the flammable objects or materials (such as walls, ceilings...etc.) Be especially careful around any gasoline and fuel products.
- Never storage the value body with the combustibile material.



KA-PT600E PRO-Torch (European Type)

- Automatic ignition propane
- Powered pro-torch

The heavy duty KA-PT600E type provides the most powerful and stable propane flame available for demanding jobs where the highest BTU output is required. Its precision orifice and controls offer the best there is in a high output propane tool. The rotating hand protection plate makes using the KA-PT600E comfortable at most any angle. KA-PT600E was designed with features to withstand the rigors of daily professional use.



Features:

- Powerful wind-resistant flame.
- Patented rotating hand protection plate for safe use at any angle.
- High output flame for plumbing and other heavy duty jobs at home and in the workplace.
- Use safely at any angle.

Specifications:

Dimension	H(w/o stand)	138mm (5.4")
	L	100mm (3.9")
	W	36mm (1.4")
Weight (when gas-filled)		280 g
Torch		1300°C (2400°F)
Gas container capacity		60 ml
Operation capacity (one gas filling)		120min. At mid setting

Applications:

Brazing, soldering, plumbing, BBQ grill charcoal starter, tool and die shops, automotive and truck repairs, industrial maintenance

Instructions:

- Connect KA-PT600E to propane canister by screwing down until it tightens.
- To ignite, turn regulator knob counterclockwise (left) approximately 1/4 turn to start the gas flow and then push ignition button. You may have to push ignition button more than once depending on conditions.
- Rotate regulator knob to the LEFT for higher flame or to the RIGHT for lower flame.
- If using the torch upside down, the flame may continue to burn for 10 seconds after turning off gas.
- When replacing or disconnecting the propane canister, make sure that the regulator knob is tight in the OFF (right) position to avoid leaking.
- Disconnect torch from cylinder when not in use.
- Within 2 minutes of ignition, the flame may appear red. During this time the torch should only be used in an upright position. After 2 minutes of preheating the torch may be rotated to any angle.

Warning:

- Only use the torch in a well-ventilated area.
- Carefully follow the instructions and warnings and familiarize yourself with the torch before use. Failure to follow these instructions could cause property damage, personal injury or death.
- Be aware that the tip of the torch can get extremely hot during or after use. Keep the torch away from children. Do not touch the torch nozzle after use.
- Never connect to a fuel cylinder near any flammable materials, chemicals, liquids or gases.
- Always point the torch flame away from the flammable objects or materials (such as walls, ceilings...etc.) Be especially careful around any gasoline and fuel products.
- Never storage the value body with the combustible material.

