



**Flexible 3 LED / UV Light Inspection Light with Magnetic**

- Adjustable for All Illuminating Purpose.
- Can be firmly attached to any metallic surface.
- LR-44 Battery x 3 PCS is included.
- Patent Pending

- KA-4495 7" with LED light
- KA-4496 10" with LED light
- KA-4497 12" with LED light
- KA-4495V 7" with UV light
- KA-4496V 10" with UV light
- KA-4497V 12" with UV light
- KA-4497LV 15" with UV light



**KA-4484N 1watt LED Clip Flashlight**

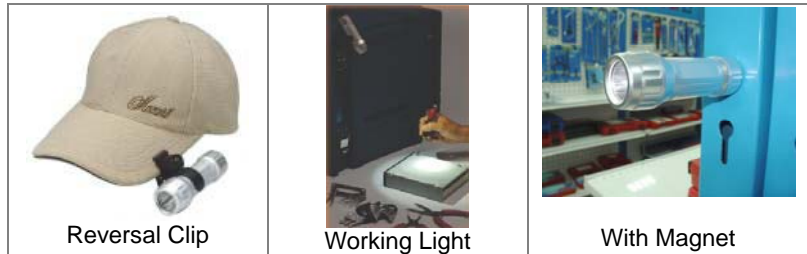

**KA-4484N3 3 watt Lantern Flashlight Trafficator**

- 3 function switch: -- 100% bright -- 70% bright -- flash signal
- Multi-functional
- Durable
- Portable
- Stylish design
- Confirm grip handle



	Flashlight with magnet
	Lantern
	Trafficator

**KJ-LED-02R**  
**30 LED Cordless Work Light With Magnetic**  
**Base & 360° Revolving Hook**



**All parts made in Taiwan**  
**Whole light assembled in Taiwan!!**

- Material: Plastic
- Characteristics:
  1. Super bright 30 LED bulbs and energy-saving.
  2. Portable for all lighting purposes
  3. 360°revolving hook
  4. 120°revolving tube
  5. Magnetic base.
  6. Light body folds 180°
  7. Convex Lens for precise focus.
  8. Working hours: 8-10 hours
  9. 2000 mAh AA nickel-metal hydride battery
- Purpose
  1. Car- repairing.
  2. Outdoor illumination (camping barbecue)
  3. Car interior illumination
  4. Emergency illumination
- Installation
 

Three kinds of power supply:

  - (a) 12 V Battery Clip
  - (b) 12 V Cigarette Lighter
  - (c) Transformer input 100V or 240V SC with Output 12V DV 400MA

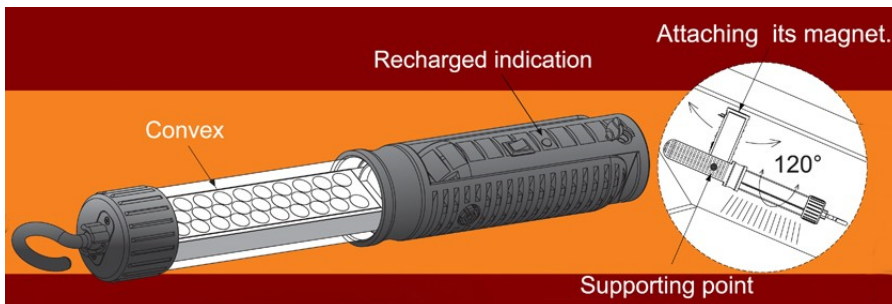
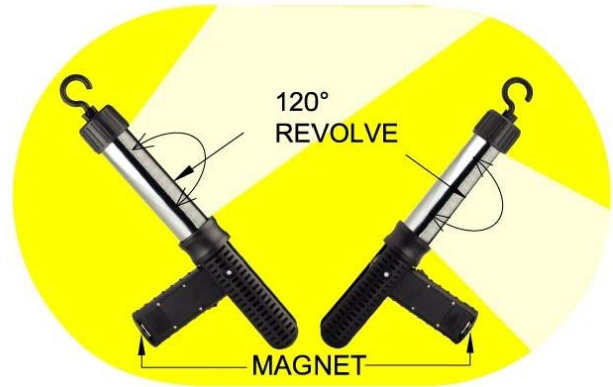
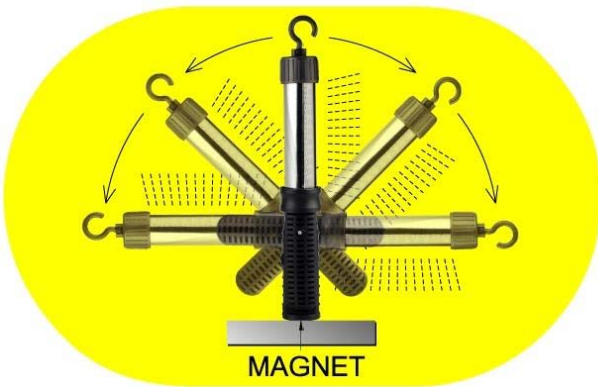

**PATENT PENDING: U.S.A, UK, DENMARK, TAIWAN, CHINA**



**KJ-LED-06R 30 SMD 5050 LED Work Light With Rechargeable and Magnet**

**Features:**

- With a strong magnet & 180 degree folding body.
- S-hook for hanging on the object.
- 120 degree revolving tube.
- 4 levels brightness. The 5th step is flash mode.

**Battery Use Notes:**

- Using the 2200 mAh Li battery.
- The light must be fully charged when the first time use it.
- The battery should be charged and discharged when it's lacking energy or not be used for a prolonged period to protect the battery's life cycle.
- Input: AC100V~240V / Output: USB DC 5V 1A.

**Notes:**

- Recharged indication: please turn off the light when recharging it.
- Red light: the light need to be recharged.
- Green light: the light is fully charged.



Patented in U.S.A., GERMANY, UK, JAPAN, TAIWAN

\* Made in Taiwan \*

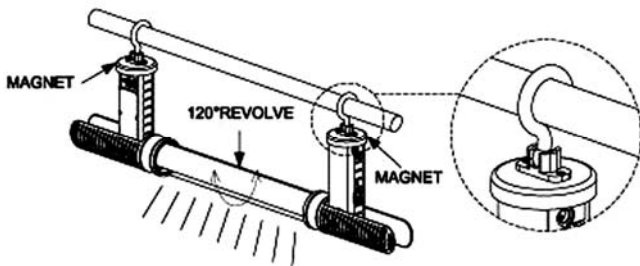

Hanging from the Top

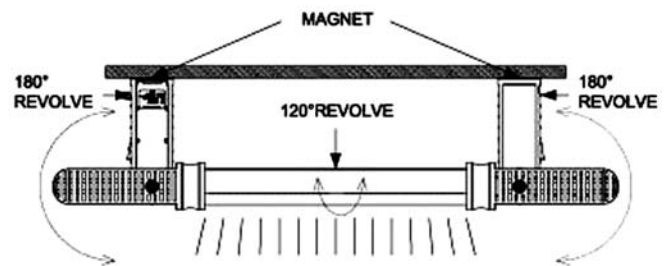

Attaching on metal surface from top or under

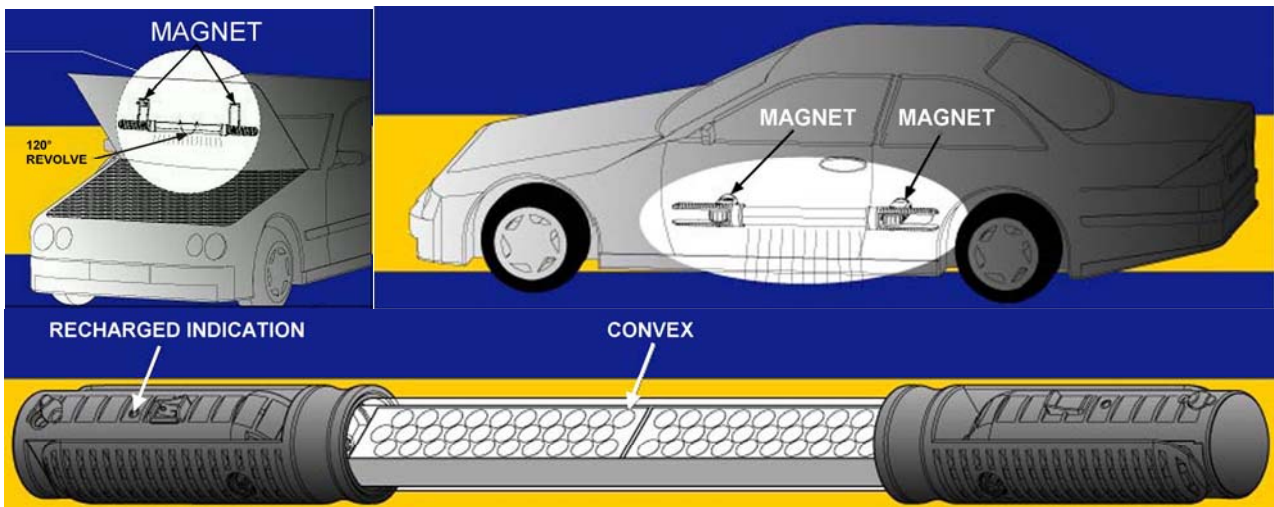

SMD 5050 LED Work / Warning Light



**KJ-LED02RFR** All RED Mask  
**KJ-LED02RFB** All BLUE Mask

- Rechargeable, Cordless
- 2200 mAh Li battery
- 120° Revolving Tube
- 360° Revolving Red or Blue Mask
- 360° Hook
- Magnetic Base
- Convex Focus Light
- AC / DC Transformer: Input: AC100V~240V / Output: USB DC 5V 1A.
- Recharge Indication
- 4 levels brightness. The 5th step is flash mode.

Patents: UK/DE/TAIWAN/CHINA/JP/USA



30 SMD 5050 LED Work / Warning Light

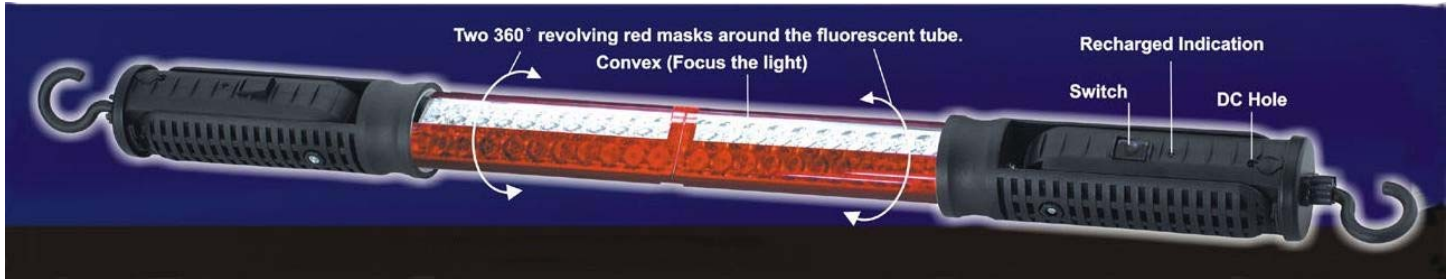
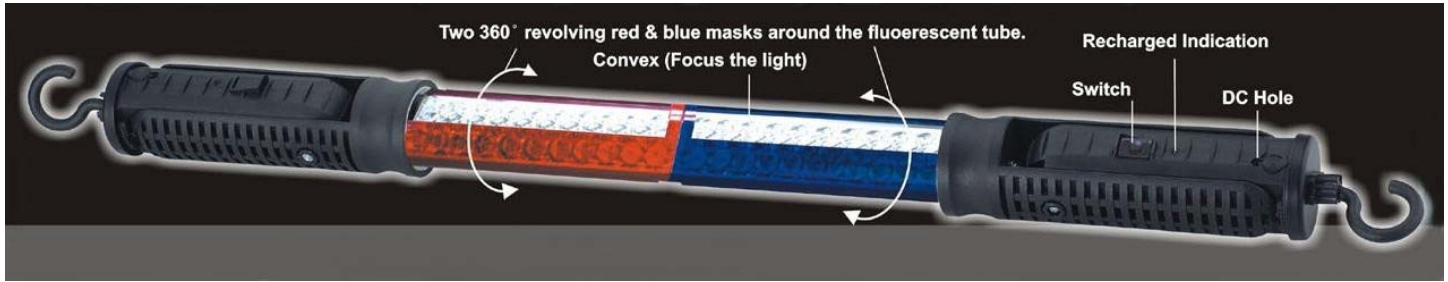

- KJ-LED06RFR** All RED Mask
- KJ-LED06RFB** All BLUE Mask
- KJ-LED06FRB** RED & BLUE Mask

- Rechargeable, Cordless
- 2200 mAh Li battery
- 120° Revolving Tube
- 360° Revolving Red or Blue Mask
- 360° Hook
- Magnetic Base
- Convex Focus Light
- AC / DC Transformer: Input: AC100V~240V / Output: USB DC 5V 1A.
- Recharge Indication
- 4 levels brightness. The 5th step is flash mode.

Patents: UK/DE/TAIWAN/CHINA/JP/USA

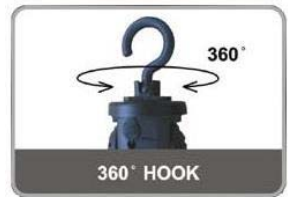
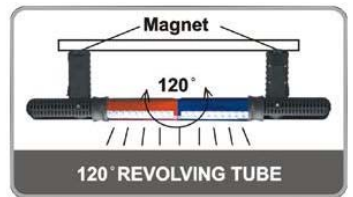



**KJ-003S**

**3 LED LIGHT WITH MAGNET FOR JACK**

\* Specially designed to be used with Jack

- 3 LED Bulbs.
- Extendable Magnetic Base.
- Mirror: 45°~135° Rotation.

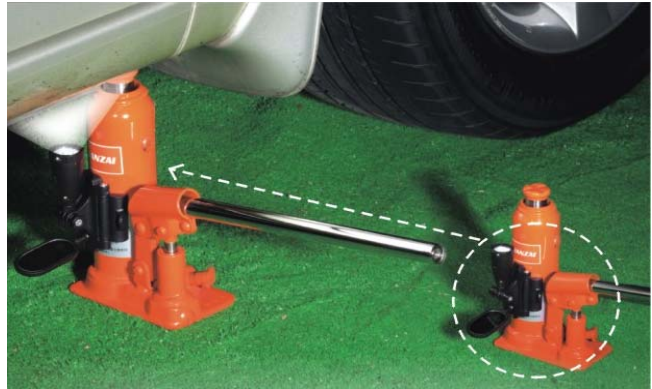

**PURPOSE / CHARACTERISTICS**

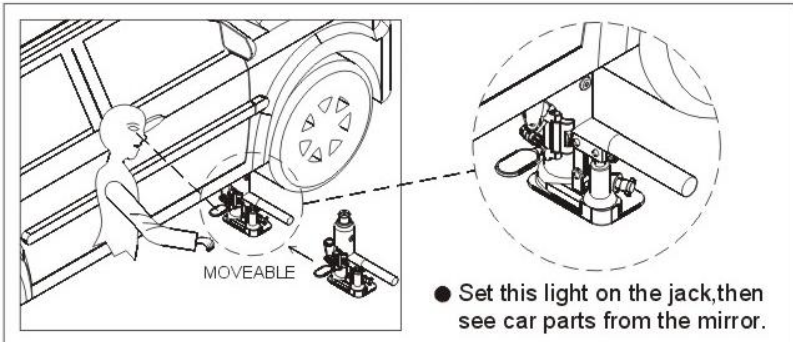

- Set this light on the jack, then see car parts from the mirror.

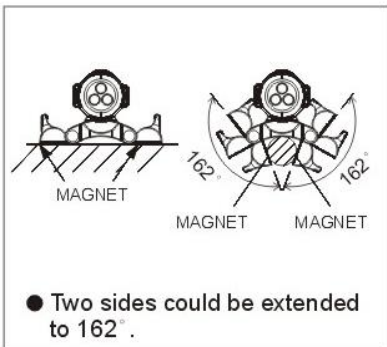

- Two sides could be extended to 162°.

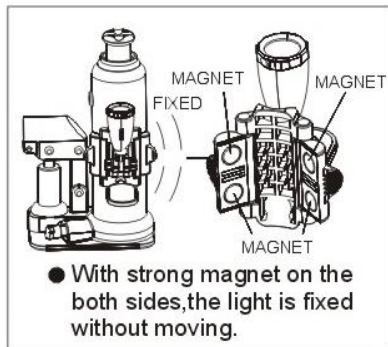

- With strong magnet on the both sides, the light is fixed without moving.

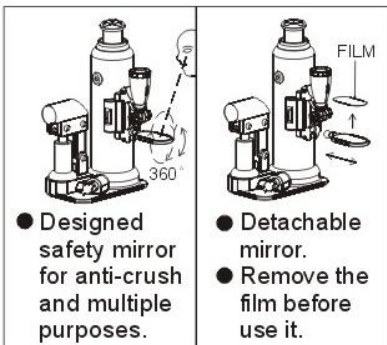

- Designed safety mirror for anti-crash and multiple purposes.
- Detachable mirror.
- Remove the film before use it.

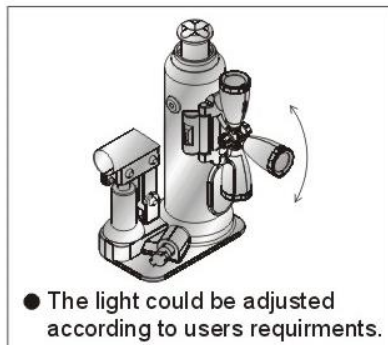

- The light could be adjusted according to users requirements.

**INSTALLATION**

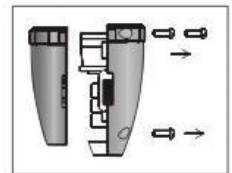
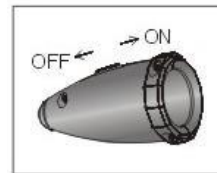

- Remove the 3 screws then disassemble the body.

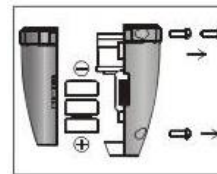

- Load the LR-44 batteries into the body. Positive electrode side (+) down.

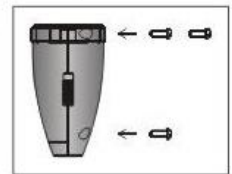

- Assemble the body by tightening the screws.



AC 100V ~ 240V (OUTPUT DC12V)  
**37 LED WORK LIGHT**



#### KA-4336C-1 37 LED Work Light

- 31 LED + 6 LED work light
- Wire Length: 25 FT (7.5 M)
- Size: 340 x 105 x 60 mm
- Charger Input: AC 100V- 240V
- Charger Output: DC 12V (250-300 MA)

DC12V **37 LED WORK LIGHT**



#### KA-4336C-2 37 LED Work Light

- 31 LED + 6 LED work light
- Wire Length: 25 FT (7.5 M)
- Size: 340 x 105 x 60 mm
- Charger Input: DC12V
- Charger Output: DC 12V (250-300 MA)
- Cigarette Plug
- Battery Clip

## Super Bright Multi-Purpose Portable LED Working Light



360° swivel hook for great positioning



- Housing Material: Plastics
- Dimension: L330 x W95 x H120 mm
- Batter: 3.6V 3300mAH NI-MH
- Charging Time: 5 hours
- Active Time: Single Light: 4~4.5 hours / Double Light: 2~2.5 hours
- Charging Mode: DC 12V / AC 100~240V
- N.W. : 0.8kgs

- KA-3512** 2 super bright LED light(1W) in front + 6 LED light on top
- KA-3512UV** 2 super bright LED light(1W) in front + 6 U.V. light on top
- KA-3512A** 2 super bright LED light(1W) in front + 1 piranha LED light on top

To be launched later:

- KA-3512B** 2 super bright LED light(3W) in front + 6 U.V. light on top
- KA-3512C** 2 super bright LED light(3W) in front + 1 piranha LED light on top

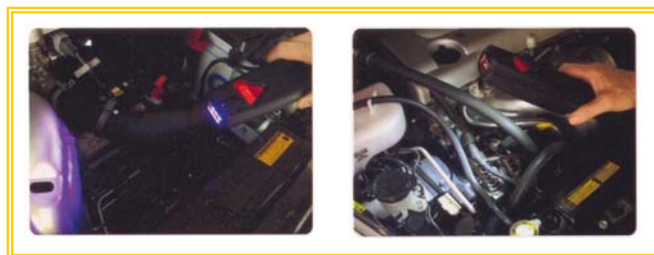

## KA-3513 Multi-Purpose Portable LED Working Light With Magnet



- Housing Material: Aluminum
- Dimension: L210 x W27 x H30 mm
- Numbers of LED: 4 super bright SMD LED light
- Battery: 3.6V 800mAH NI-MH
- Charging Time: 2.5 hours
- Active Time: 2~2.5 hours
- Charging Mode: DC 12V AC 100~240V
- N.W.: 0.2kgs



## KA-3514 Clip-ON / Free Standing Multiple Purpose Portable Super Bright LED Working Light Set



- Housing Material: Aluminum
- Dimension: L666 x W140 x H45 mm
- Numbers of LED: 90 piranha LED light
- Voltage: AC 100~240V DC 12V
- N.W.: 1.8kgs
- Works with one folding pod included







**360° Multi-Purpose Portable Working Light With Magnet Base**

- Housing Material: Plastics
- Dimension: L185 x W145 X H90 mm
- Number of LED: 1 super bright LED light
- Number of Magnet at Base: 6
- Battery: 3.6V 2000mAh NI-MH
- Charging Time: 5 hours
- Active Time: 4~4.5hours
- Charging Mode: DC 12V AC 100~240V
- N.W.: 0.6kgs

KA-3516 1W  
KA-3516A 3W



**KA-1361 5W LED Working Light**

- Aluminum and plastic.
- Magnetic base

**Specification:**

- Light source: CREE 5W LED (300lm)
- Battery: 3.8V/2400mah
- Replenisher: i/p 100-240Vac, o/pSv/1Adc(Micor USB)
- Total length: 430mm
- Weight: 230g
- Use time approx: 3-4 hours
- Charging time approx: 3-4 hours

**KA-3519 Cobra Light**

- Power is supplied by cartridge-style battery, easy to replace.
- Unit has 1W high power Lumens LED that provides brightness as 15 LEDs.
- LED Lifetime rates up to 30,000 hours, 30times than normal bulb.
- Super Strong magnets is inserted in the bottom, can be fixed on metal surface.
- The 40cm neck can be easily fixed by winding and stretched into the narrow cap.
- No heat prevents from scalding. Insulation design prevents the short circuit.
- 2000mAH battery can be used between 6~9 hours serially and saving electrical power.
- Find engine, transmission, radiator, air condition and other leaks quickly and easily by using UV light. (optional function)

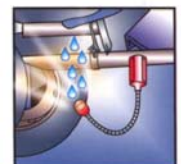

Oil-Resistant



Secure Firmly

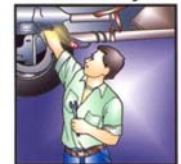

Winding Cord

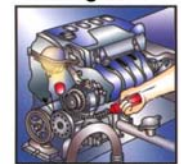

Reach any deep area

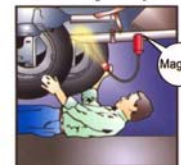

Strong Magnet



**Multipurpose Foldable Work light**

ITEM NO.	KA-3501A	KA-3501B
Housing Material	Plastic Housing	
Size (mm)	52(L) x 48(W) x 105(H)	
LED Q'ty	12pcs + 3U.V	12 + 3LED
Battery	DC 1.5V x 3	--
Active Time	4.5h(1600mAh LED x 12), 17h(1600mAh LED x 3)	
Weight	195mg	145mg
ED-915(H.M.C)	○	○



**Foldable Rechargeable Emergency Work light**

ITEM NO.	KA-3502A	KA-3502B
Housing Material	Plastic Housing	
Size (mm)	60(L) x 55(W) x 55(H)	
LED Q'ty	21 + 6LED	21LED + 6U.V
Power Input	AC 110 ~ 220V	AC 110 ~ 220, DC12V
Battery	3.6V 2.2Ah NI-MH	3.6V 3.3Ah NI-MH
Active Time	5 ~ 6 hours	9.0 hours
Charger Time	5.5 hours	8 ~ 9 hours
Weight	560mg	620mg



**10W LED Rechargeable Work light**

ITEM NO.	KA-3504
Housing Material	Steel Housing
Size (mm)	200(L) x 230(W) x 280(H)
LED Q'ty	10W LED Light
Power Input	AC 100 ~ 240V
Power Output	DC 12V
Battery	12V 4.5Ah VRLA
Weight	5.8kg



**10W LED Work light**

ITEM NO.	KA-3503	KA-3503A	KA-3503B
	AC & DC rechargeable	Not rechargeable	Not rechargeable
Housing Material	Plastic Housing		
Size (mm)	330(L) x 95(W) x 100(H)		
LED Q'ty	10W MULTI-CHIP MODULE	10W x 1	10W x 1
Power Input	AC100 ~ 240v, DC 12V	AC 100 ~ 240V	DC 12 ~ 24V
Battery	3.6V 3300mAh NI-MH	--	--
Wire Length	--	25ft(7.5M)	20ft(7M)
Charger Time	5.0 hours	--	--
Active Time	4 ~ 4.5 hours/1LED	--	--
Weight	0.8kg	1.5kg	1.0kg

- High power 10W LED
- 360° adjustable hook
- Super Luminosity over 700LM
- Waterproof Grade IP44
- Heavy-Duty magnet included

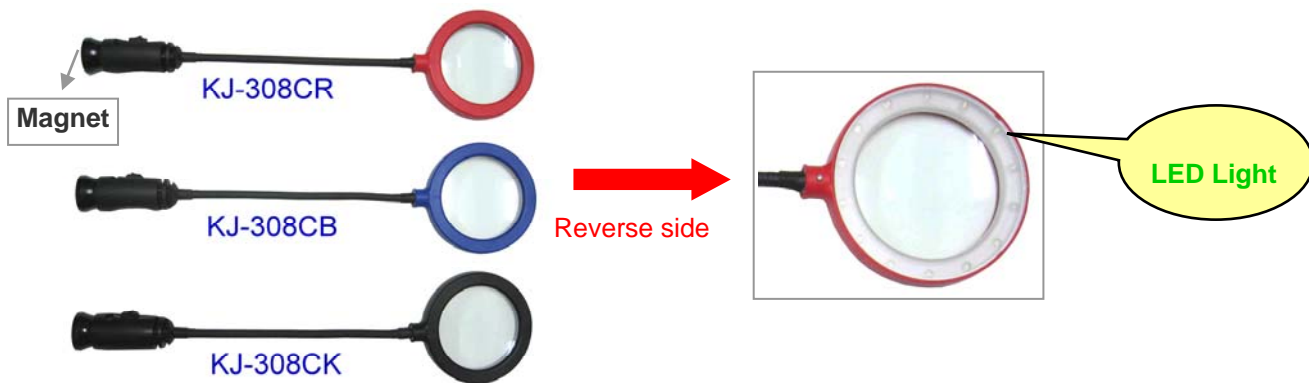

14 LED Flexible Work Light With Magnifying Glass (LED Dual Power)

- LED white light bulb.
- Waterproof
- 3x magnifying glass.
- Magnifying glass's diameter is 4".
- Could be supplied power by the two kinds of options which are the 2pcs of AAA battery and transformer.
- Magnetic base attaches firmly to any metal surface.

Accessories:

It could be supplied power by the below options:

1. Battery- 2pcs of AAA battery
2. Transformer- Input: AC100V/AC240V, Output: 4.5V DC 500mA.
3. C-Clamp (metal)

Light Purpose:

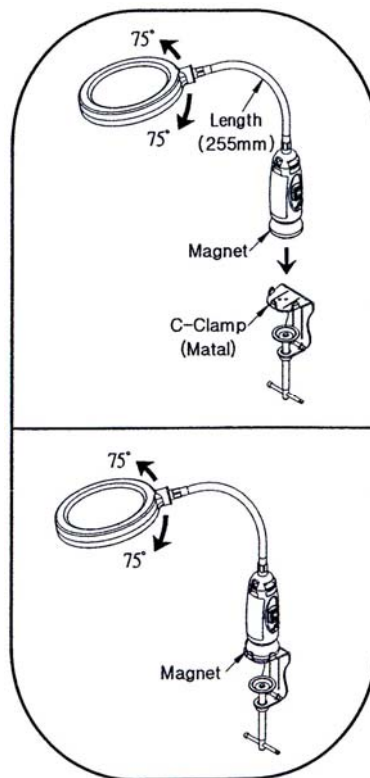
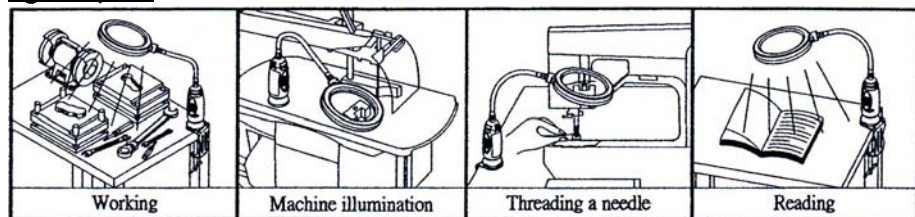

Optional Accessory:

KJ-308CD 4.5V Spare Transformer For KJ-308C Series



Magnetic 14 LED Light With 3x Magnifying glass

- LED white light bulb.
- Waterproof
- 3x magnifying glass.
- Magnifying glass's diameter is 4".
- Could be supplied power by the two kinds of options which are the 2pcs of AAA battery and transformer.

Accessories:

It could be supplied power by the below options:

1. Battery- 2pcs of AAA battery
2. Transformer- Input: AC100V/AC240V, Output: 4.5V DC 500mA.



KA-1090  
10W Chip LED Working Light



KA-1091  
9W High Power LED Working Light



KA-1092  
30pcs LED Working Light



KA-1093  
6W 5050 SMD LED Working Light



KA-1094  
6W LED Working Light  
& Warning Light



1pc top light of 3W  
high power LED light

The Bendable Handle allow the light itself can stand alone and bend to any direction where need the lights

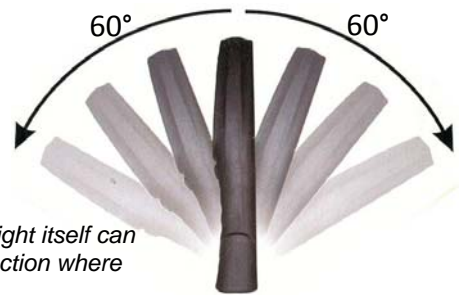

**Features:**

- Angle Adjustable-lets you adjust light where you need it
- Li-Ion rechargeable Battery – 3.6V 2250mAh
- AC/DC charger – AC 100 -240V, DC 12V – 24V
- Magnetic Base – High strength magnets stick to metal surfaces
- Charge Time: 3.5 hours
- Waterproof grade: IP65
- Bright LEDs: 50,000 hours life
- 360° Swivel Hook
- Hard-coated lenses and Slip resistant textured body
- Fully rubberized and impact resistant housing



KA-1095

Focus Adjustable

Button Switch



KA-1096

Focus Adjustable

Magnet



KA-1098

Spotlighting  
Focusable LED  
Wide range illumination  
Flexible shaft  
Dim  
Bright  
On / Off  
Brightness  
Dial  
Worklight  
Charge  
Indicator  
Micro USB  
Charging  
socket  
Strong  
Magnetic  
Base

5W Focus Adjustable 360° Multi-Purpose Portable Working Light With Magnet Base

<b>Maximum Brightness</b>	Wide beam 360 Lux at 50cm, Intense Spot 10000 Lux at 50cm Notes: wide beam diameter: 158cm/intense spot diameter: 13cm
<b>Battery</b>	1PC x Lithium battery ICR Sanyo 18650A 2250 mA/3.7V
<b>Running Time</b>	High light 2.5~3 hours, low light 8~9 hours
<b>Recharge Time</b>	Four modes can switch back and forth 3.5 hours
<b>Four Gears</b>	High Lighting-Low Lighting-Flash(SOS) Lighting and off Four modes can switch back forth
<b>Head Adjustment</b>	Tilts 180 degree
<b>Material</b>	High Quality Aluminum Alloy (Eco-friendly)
<b>Dimensions</b>	Over all length 168mm, Head dia: 28mm, Body dia: 37mm
<b>Waterproof Grade</b>	IP 65
<b>LED Life Time</b>	50,000 hours
<b>Charge Cycles</b>	Over 500 times
<b>Lighting Range</b>	Max: 150M
<b>Magnets</b>	Build in bottom
<b>Charger</b>	Intelligent Two Chargers: (1) AC adapter input: 110 – 240V, 50-60Hz, Output: 5V, 1000mA (2) Car adapter: input DC 12-24V, Output: 5V, 1000mA
<b>Included</b>	5W Zoom LED Torch, rechargeable LI-ION batteries: 110V AC and 12V DC battery charger, instructions, leather cover(optional)
<b>Net Weight</b>	240g(with battery), 580g(cover + 2 chargers + gift box)



**LED PENLIGHT**

**Features:**

Size: 165 x 25 x 30mm

- Battery: 3 x AAA super heavy duty 1.5V batteries last up to 10 hours of non-stop use (included)
- Weight: 65g (including batteries)
- Storage temperature: -20°C to 70°C
- Operation temperature: -5°C to 50°C
- 360° rotatable clip with molded magnet for convenience usage.
- Powerful magnet

**KA-1085** 2W Hi intensity LED light

**KA-1086** 8W COB LED light

**KA-1087** 2W Hi intensity LED light + Red/Blue warning light

\* Standard color: Red with black

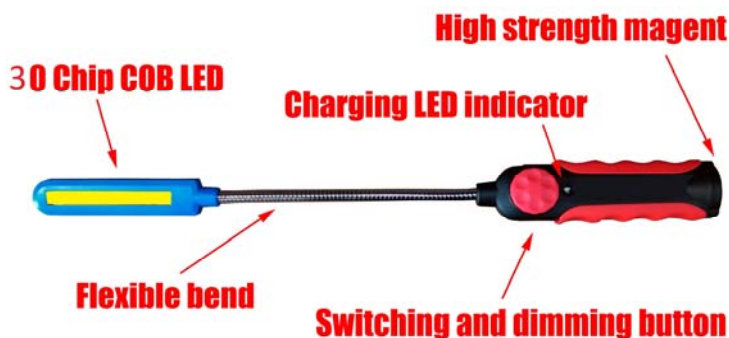

**KA-1348**  
8W Flexible Rechargeable COB LED Slim Light

- Unique flexible neck allows you to mount the magnetic base then just bend and twist the light into the desired position.
- 20lb magnetic base.
- Unique power dial to adjust from 0~300 lumens or anywhere in between.
- Rechargeable Lithium-ion battery 3.7V 2200 mAh.
- USB rechargeable (includes wall adapter and Micro USB cable)
- 4-10 hours work time.
- Charging time 3.5~4 hours.
- Externally and internally designed for harsh conditions and dirty environments.
- Overcharge protection.

**Specifications:**

- LED max power: 8W LED COB light
- Li-ion rechargeable battery: 3.7VDC 2200mAh
- Charge input: AC100-240V 50/60Hz
- Power output: 5.0V 1000mAh
- Charge time: 3.5 ~ 4.0 hours
- Active time: 4 hours (100% power) up to 10 hours (50% power or less)
- Operation temperature: -20°C to 50°C
- Housing material: composite
- Dimensions: 17.5" x 1.57" x 1.46"
- Weight: 0.5 lbs

**KA-1329 48 LED Work Light**

- Folding design, 180° fully folded
- Patented new design, sleek, lightweight, particularly good texture, comfort grip.
- All folding design, 180° fully folded 1/2 smaller in size, easy storage and portability.
- Innovative design, automatic IC sensor switch, turn on the use of that light, when folded back off, do not press the switch can be used to increase their convenience, can extend the switch life.
- The intimate design battery replacement mode, the battery is of the consumable, when returned to the factory no need to replace the battery damage, simply purchase another consumer replaceable batteries can, moreover, when you have to work long hours of battery power exhausted, without waiting for the charging time, put already fully charged backup battery can continue to complete your work, increase work efficiency.
- The lighting design transparent protective cover can be replaced with the light dimmed when your lamp might be defaced transparent cover, this time as long as the transparent protective cover replacement, illumination and can restore the original brightness.



<p>Transparent mask if fouling, they can always replaceable.</p>	<p>IC sensor switch automatically opens that is the use of light, when folded off, without pressing the switch can be used.</p>	<p>The new patented folding design can be completely folded body 180° narrow plot 1/2, sleek</p>

**45° Rechargeable Swivel Led Light With Magnet**

- The battery body could be disassembled from the lamp for another lamp.
- 45° swivel lamp body for better operation angel.
- With power magnet in the bottom of lamp and hanger in the top of lamp
- Electronic switch for easier operation.



KA-3500



KA-3500A

	KA-3500	KA-3500A
<b>Light</b>	30 LED	9W
<b>Battery:</b>	3.7V/2400ma (Li-Lon) x 1pc	3.7V/2400ma (Li-Lon) x 2pc
<b>Recharge time:</b>	5-6 hours	5~6 hours
<b>Working time:</b>	4-5 hours	6~8 hours



**KA-1084 15W Ultra LED COB Slim Working Light**

- Ideal for illuminating hard to reach/small areas
- The adjustable dimmer switch allows you to set the amount of light you need
- 360° Swivel Magnetic base can be locked into any position
- 180° swivel hook
- Charger and Micro USB cable included

**Specification:**

LED max power:	410 Lumens 15W LED COB light
Li-ion rechargeable battery:	2200mAh
Charger time:	3.5~4 hours
Power output:	5.0V 1000mAh
Active time:	2.5 hours at full power
Storage temperature:	-20°C to 70°C
Operation temperature:	-5°C to 50°C
Product size:	375(L) x 40(W) x 30(H) mm
Charge indicator light:	Red (charging) Blue (charging complete)

- Keep the LED light away from fire / water or heat / damp place.
- Do not immerse the LED light in water / solvent.
- Do not shine the LED light directly on anybody's eyes.



**20W LED COB Slim Work Light**

- Ideal for illuminating hard to reach/small areas
- The adjustable dimmer switch allows you to set the amount of light you need
- 360° Swivel Magnetic base can be locked into any position
- Tip folding hook on both ends
- Charger and Micro USB cable included

**Specifications:**

LED max power:	800 Lumens 20W LED COB Light
Li-ion rechargeable battery:	3350mAh
Charger time:	3.5~4 hours
Power output:	5.0V 2000mAh.
Active time:	3 hours at full power
Storage temperature:	-20°C to 70°C
Operation temperature:	-5°C to 50°C
Product size:	477(L) x 50(W) x 40(H)mm
Charge indicator light:	Red (charging) Blue (charging complete)

- Keep the LED light away from fire / water or heat / damp place.
- Do not immerse the LED light in water / solvent.
- Do not shine the LED light directly on anybody's eyes.



- KA-1359Y** Nature White + Yellow Light
- KA-1359R** Nature White + Warning Light
- KA-1359B** Nature White + UV Light

Item No.	Light	Lumen	Lumen-Dual Color	Color Temperature (K)
KA-1359Y	Nature White + <b>Yellow light</b>	Nature White 620 Lm	770 Lm	5200 K
		Yellow light 600 Lm		3000 K
KA-1359B	Nature White + <b>Blue light</b>	Nature White 620 Lm	485 Lm	5200 K
		Blue light 141Lm		450 nM
KA-1359R	Nature White + <b>Red light</b>	Nature White 620 Lm	616 Lm	5200 K
		Red light 176 Lm		620 nM



**KA-1357**  
**2-IN-1 LED Focus Adjustable Flashlight / COB**  
**Work Light**

**Instruction:**

- Lumen switch-turn for on/off, then turn the switch slightly right or left for necessary light.
- Built-in 2200 mAh Li-ion battery capacity.
- Charging battery-use USB charger and USB cord connected to the USB charging port and then plug into socket for re-charging.
- Focus Adjustable.
- LED Charging Indicator:  
 Red Light On – in charging  
 Blue Light On – completely charged
- Product size: 230(L) x 30(W) x 40(H)mm

**Caution:**

- A. LED max power: 400 Lumens 8W COB LED + 3W tip light.
- B. Power output: 5.0V 1000mAh.
- C. Charger time: 3.5~4.0 hours.
- D. Active time: more than 3 hours.
- E. Storage temperature: -20°C to 70°C.
- F. Operation temperature: -5°C to 50°C.
- G. Charger input: AC100~240V 50/60Hz.
- H. Keep the LED light away from fire/water or heat/damp place.
- I. Do not immerse the LED light in water / solvent.
- J. Do not shine the LED light directly on anybody's eyes.



**KA-1358**  
**350 Lumen Rechargeable COB Light**

**Features:**

- Micro adjustment lumen switch.
- Twin magnet on rear and bottom.
- Comes with belt clip.
- Build in 2200 mAh Li-ion battery.
- For full light – approx. 4 hours working hours, for semi light – approx. 12 working hours.
- 4 hours charging time:  
 In charging – red indicator light on,  
 Charged completed – blue indicator light on.
- Comes with 5V 1A USB charger & USB cable

**Specifications:**

- A. LED max power: 8W LED COB light.
- B. Li-ion rechargeable battery: 3.7V 2200mAh.
- C. Charger input: AC100~240V 50/60Hz.
- D. Power output: 5.0V 1000mAh
- E. Charger time: 3.5~4.0 hours.
- F. Active time: 4 hours.
- G. Storage temperature: -20°C to 70°C.
- H. Operation temperature: -5°C to 50°C.
- I. Product size: 215(L) x 27(W) x 30(H)mm.



High Strength magnates





**LED Work Light**

- Material: Aluminum
- LED type: 5050 SMD
- LED color: Clear
- 180° adjustable AL crust.
- Bright light despite low current draw.
- Easy to install. On both sides of the magnet and mounting holes (with 6 screws).

	KA-9055A	KA-9055B	KA-9055C	KA-9055AC	KA-9055BC	KA-9055CC
27 LED Bulbs (15") 38cm	•			•		
36 LED Bulbs (20") 50cm		•			•	
45 LED Bulbs (25") 63cm			•			•
Power supplied	1. Power: AA battery x 8pcs 2. Power box with a switch and magnet on the back.			By the below options: 1. Battery clip - 12V 2. Cigarette lighter - 12V		



**Multifunctional LED Water-Proof Working Lamp**

**Specification:**

- Lamp Dimension: 2 FT / 4 FT
- Power: 2 FT-10W / 4 FT-20W
- Lumen: 2 FT-800lm / 4 FT-1600lm
- Color: 4000K / 5700K
- Voltage: DC12V,24V / AC100V~240V
- Wire Length: 8FT / Customized
- **Water-Proof Level: IPX6**
- Plug: Cigarette plug & battery clamp / European regulation / US regulations
- Certification: IPX6

**Advantage:**

- Waterproof design. Can be used in raining day.
- With S hooks / Powerful Magnet hanger

- KA-1362A2** 2FT with AC power supply
- KA-1362A4** 4FT with AC power supply
- KA-1362D2** 2FT with DC power supply
- KA-1362D4** 4FT with DC power supply

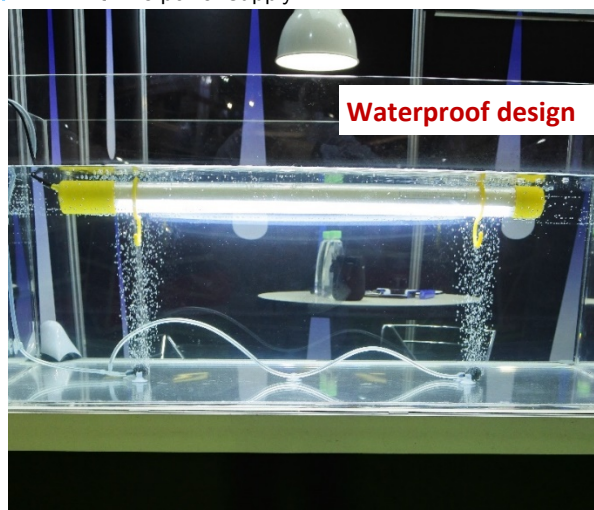
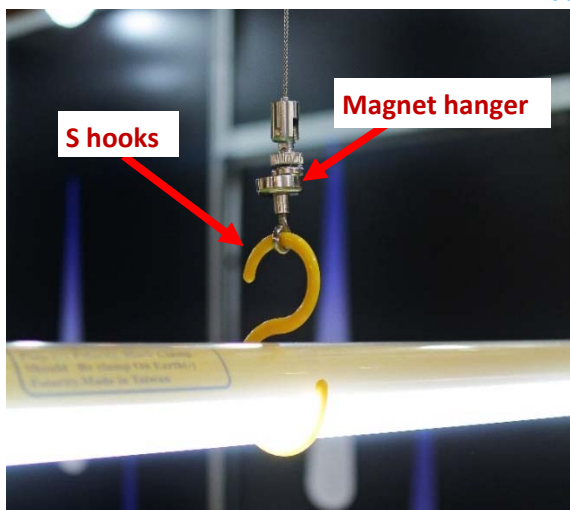



## Multifunctional Portable LED Light

### Features:

- Portable.
- Color temperature changeable.
- No flicker.
- Emergency lighting function.
- Several fixed modes.

- KA-1363W** white color
- KA-1363B** black color
- KA-1363R** red color



### Several Fixed modes:

#### Indoor

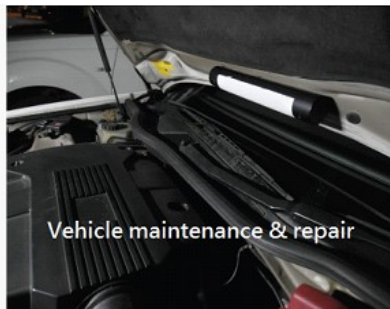

#### Outdoor

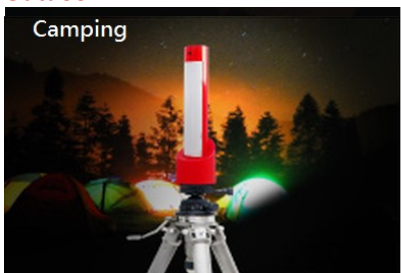

### 3 lighting modes:

- Sequentially press the button switch within 10 seconds to select lighting modes.
- Lighting on & charging simultaneously when plug in power
- 6W LED output
- Nature white (580lm)/ cool white (540lm)/ warm white (500lm)

Stage 1	Stage 2	Stage 3	Stage 4
Nature White	Cool White	Warm White	Off



\* Any lighting mode lasts more than 10 seconds, the next press also can turn off the light.

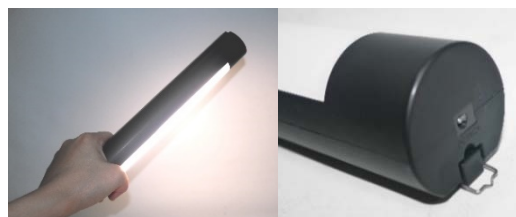

**Attracts iron object or any magnetic object.**



**Hangs up by one side / two sides**



### Specification:

- Input Voltage: 100V~240V AC / 50~60Hz (DC output 5V, 2A)
- Power Consumption (Typ.): 12W max. (lighting + charging)
- Color Temperature: 6000K / 4000K / 3000K
- Luminous Flux: 580lm / 540lm / 500lm
- CRI: > 80
- Work Temperature: -20°C ~ 40°C
- LED Life Time: 40,000 hours
- Charge Time: about 10 hours
- Lithium-ion Batter: 3.7V, 5200mAh
- Dimension(L\*W\*H): 40\*38\*260mm
- Net Weight: 205g
- Material: PC, ABS
- Color: White, Black, Red

### Lighting function:

<b>With Power</b>	Press button switch to select 3 lighting modes: 1. Nature white 2. Cool white 3. Warm white
<b>Power Failure</b>	Automatically lights on (Nature white) Press button switch to select 5 lighting modes: 1. Nature white: 3 hours 2. Cool white: 3 hours 3. Warm white: 3 hours 4. Nature white half illumination: 6 hours 5. Flash (S.O.S.) in warm white: 12 hours