

KA-S4140A-BP 140pcs 1/4" & 3/8" & 1/2" Dr. Socket Set

Contents:

- 1-BLOW MOLD CASE
- 1/4"DR.
- 11-SOCKET 4-4.5-5-5.5-6-7-8-9-10-11-12MM
- 10-SOCKET 5/32" - 3/16" - 7/32" - 1/4" - 9/32" - 5/16" - 11/32" - 3/8" - 7/16" - 1/2"
- 5-DEEP SOCKET 8-9-10-12-13MM
- 5-STAR SOCKET E4-E5-E6-E7-E8
- 1-BIT COUPLE 1/4"DR X 1/4"BIT
- 1-RATCHET HANDLE
- 1-UNIVERSAL JOINT
- 1-EXTENSION BAR 100MM
- 1-MULTI-SPANNER HANDLE
- 21-BIT SOCKET 4-PH:0-1-2-3 3-SL:4-5.5-6.5 4-HEX:3-4-5-6
10-TX:T7-T8-T9-T10-T15-T20-T25-T27-T30-T40
- 3/8"DR.
- 7-SOCKET 13-14-15-16-17-18-19MM
- 6-SOCKET 9/16" - 5/8" - 11/16" - 3/4" - 13/16" - 7/8"
- 3-DEEP SOCKET 14-15-17MM
- 6-STAR SOCKET E10-E11-E12-E14-E16-E18
- 1-RATCHET HANDLE
- 1-UNIVERSAL JOINT
- 2-EXTENSION BAR 75MM - 150MM
- 1-MULTI-ADAPTOR 3/8" F X 1/2" M
- 1-SOCKET ADAPTOR 3/8" F X 1/4" M
- 1/2"DR.
- 7-SOCKET 20-21-22-24-27-30-32MM
- 4-SOCKET 15/16" - 1" - (1-1/16") - (1-1/4")
- 3-STAR SOCKET E20-E22-E24
- 4-IMPACT SOCKET 17-19-21-23MM
- 2-SPARK PLUG SOCKET 16MM - 21MM
- 1-RATCHET HANDLE
- 1-UNIVERSAL JOINT
- 2-EXTENSION BAR 125MM - 250MM
- 10-COMBINATION WRENCH 8-9-10-11-12-13-14-17-18-19MM
- 20-BITS

** MOQ: 300 SETS **



KA-S4160A-BP 160pcs 1/4" & 3/8" & 1/2" Dr. Socket Set

Contents:

- 1-BLOW MOLD CASE
- 1/4"DR.
- 11-SOCKET 4-4.5-5-5.5-6-7-8-9-10-11-12MM
- 10-SOCKET 5/32" - 3/16" - 7/32" - 1/4" - 9/32" - 5/16" - 11/32" - 3/8" - 7/16" - 1/2"
- 7-DEEP SOCKET 6-7-8-9-10-11-12MM
- 5-STAR SOCKET E4-E5-E6-E7-E8
- 1-BIT COUPLE 1/4"DR X 1/4"BIT
- 1-RATCHET HANDLE
- 1-UNIVERSAL JOINT
- 1-SLIDING T-BAR
- 1-EXTENSION BAR 75MM
- 1-MULTI-SPANNER HANDLE
- 11-BIT SOCKET 4-PH:0-1-2-3 3-SL:4-5.5-6.5 4-TX:T10-T20-T30-T40
- 3/8"DR.
- 7-SOCKET 13-14-15-16-17-18-19MM
- 6-SOCKET 9/16" - 5/8" - 11/16" - 3/4" - 13/16" - 7/8"
- 3-DEEP SOCKET 13-14-15MM
- 6-STAR SOCKET E10-E11-E12-E14-E16-E18
- 1-RATCHET HANDLE
- 1-UNIVERSAL JOINT
- 2-EXTENSION BAR 75MM - 150MM
- 1-MULTI-ADAPTOR 3/8" F X 1/2" M
- 1-SOCKET ADAPTOR 3/8" F X 1/4" M
- 1/2"DR.
- 7-SOCKET 20-21-22-24-27-30-32MM
- 4-SOCKET 15/16" - 1" - (1-1/16") - (1-1/4")
- 3-DEEP SOCKET 15-17-19MM
- 3-STAR SOCKET E20-E22-E24
- 2-SPARK PLUG SOCKET 16MM - 21MM
- 4-IMPACT SOCKET 17-19-21-23MM
- 1-RATCHET HANDLE
- 1-UNIVERSAL JOINT
- 2-EXTENSION BAR 125MM - 250MM
- 4-BIT SOCKET 4-TX:T45-T50-T55-T60
- 12-COMBINATION WRENCH 8-9-10-11-12-13-14-15-16-17-18-19MM
- 9-HEX KEY SET 1.5-2-2.5-3-4-5-6-8-10MM
- 30-BITS

** MOQ: 300 SETS **



KA-T466A-BS1 66pcs 1/4" & 1/2" Dr. Socket Set



- Contents:**
 1-BLOW MOLD CASE
 1/4"DR
 8-SOCKET 6-7-8-9-10-11-12-13MM
 1-BIT COUPLE 1/4"DR X 1/4"BIT
 1-SLIDING T-BAR
 1-MULTI-SPANNER HANDLE
 22-BIT 4-PH:0-1-2-3 3-PZ:1-2-3 4-SL:3-4-5-5-7 6-HEX:2-3-4-5-6-7
 5-TX:T10-T15-T20-T25-T30
 1/2"DR
 10-SOCKET 10-11-12-13-15-17-19-22-24-27MM
 2-SPARK PLUG SOCKET 16MM - 21MM
 1-RATCHET HANDLE
 1-UNIVERSAL JOINT
 1-EXTENSION BAR 125MM
 6-COMBINATION WRENCH 10-12-13-14-15-17MM
 4-HEX KEY WRENCH 3-4-5-6MM
 1-COMBINATION PLIER
 1-WATER PUMP PLIER
 5-SCREWDRIVER PH:6X38 , PH:6X100 , PZ:6X38 , PZ:6X100 , SL:8X200
 1-HAMMER 300G

** MOQ: 300 SETS **

KA-T477-BS1 77pcs 1/4" & 1/2" Dr. Hand Tool Set



- Contents:**
 1-BLOW MOLD CASE
 1/4"DR.
 9-SOCKET 4-5-6-7-8-9-10-11-12MM
 1-BIT COUPLE 1/4"DR X 1/4"BIT
 1-RATCHET HANDLE
 1-UNIVERSAL JOINT
 1-SLIDING T-BAR
 1-EXTENSION BAR 75MM
 22-BITS 5-HEX:2-3-4-5-6 5-TX:T10-T15-T20-T25-T30 BIT AD
 4-PH: 0-1-2-3 3-PZ:1-2-3 4-SL:3-4-5-5-7
 1/2"DR.
 13-SOCKET 10-11-12-13-14-15-17-19-22-24-27-30-32MM
 1-SPARK PLUG SOCKET 21MM
 1-RATCHET HANDLE
 1-UNIVERSAL JOINT
 2-EXTENSION BAR 125MM - 250MM
 4-DOUBLE FLEXIBLE SOCKET 8 X 9 - 10 X 11 - 12 X 13 - 14 X 15 MM
 11-COMBINATION WRENCH 7-8-9-10-11-12-13-14-15-17-19MM
 7-HEX KEY WRENCH 1.5-2-2.5-5-6-8-10MM

** MOQ: 300 SETS **

KA-T495A-BS1 95pcs 1/4" & 1/2" Dr. Hand Tool Set



- Contents:**
 1-BLOW MOLD CASE
 1/4"DR.
 9-SOCKET 4-5-6-7-8-9-10-11-12MM
 1-BIT COUPLE 1/4"DR X 1/4"BIT
 1-RATCHET HANDLE
 1-UNIVERSAL JOINET
 1-SLIDING T-BAR
 1-EXTENSION BAR 75MM
 40-BIT 5-PH:0-1-2-2-3 5-PZ:0-1-2-2-3 10-SL:2.5-3-4-4.5-5-5.5-6-6.5-7-8
 10-HEX:1.5-2-2.5-3-4-5-5.5-6-7-8
 10-TX:T7-T8-T10-T15-T20-T25-T27-T30-T35-T40
 3/8"DR.
 1-MULTI-ADAPTOR 3/8" F X 1/2" M
 1/2"DR.
 13-SOCKET 10-11-12-13-14-15-17-19-22-24-27-30-32MM
 1-SPARK PLUG SOCKET 21MM
 1-RATCHET HANDLE
 1-UNIVERSAL JOINET
 2-EXTENSION BAR 125MM - 250MM
 11-COMBINATION WRENCH 7-8-9-10-11-12-13-14-15-17-19MM
 4-DOUBLE FLEXIBLE SOCKET WRENCH 8 X 9 - 10 X 11 - 12 X 13 - 14 X 15 MM
 7-HEX KEY 2-3-4-5-6-8-10MM

** MOQ: 300 SETS **

KA-T480A-BS1 80pcs 1/4" & 1/2" Dr. Hand Tool Set



Contents:

- 1-BLOW MOLD CASE
- 1/4"DR
- 10-SOCKET 4-5-6-7-8-9-10-11-12-13MM
- 5-DEEP SOCKET 6-7-8-10-12MM
- 1-BIT COUPLE 1/4"DR X 1/4"BIT
- 1-RATCHET HANDLE
- 1-UNIVERSAL JOINT
- 1-EXTENSION BAR 100MM
- 1-MULTI-SPANNER HANDLE
- 22-BIT 4-PH:0-1-2-3 3-PZ:1-2-3 4-SL:3-4-5-5-7 6-HEX:2-3-4-5-6-7
- 5-TX:T10-T15-T20-T25-T30
- 1/2"DR
- 13-SOCKET 10-11-12-13-14-15-17-19-22-24-27-30-32MM
- 2-SPARK PLUG SOCKET 16MM - 21MM
- 1-RATCHET HANDLE
- 1-UNIVERSAL JOINT
- 1-EXTENSION BAR 125MM
- 8-COMBINATION WRENCH 10-11-12-13-14-15-17-19MM
- 3-HEX KEY WRENCH 1.5-2-2.5MM
- 1-LOCKING PLIER
- 1-COMBINATION PLIER
- 1-WATER PUMP PLIER
- 5-SCREWDRIVER PH:6X40 , PH:6X100 , SL:6X40 , SL:6X100 , SL:8X200
- 1- HAMMER 300G

** MOQ: 300 SETS **

KA-T4107A-BS1 107pcs 1/4" & 1/2" Dr. Hand Tool Set



Contents:

- 1-BLOW MOLD CASE
- 1/4"DR.
- 10-SOCKET 4-5-6-7-8-9-10-11-12-13MM
- 5-DEEP SOCKET 8-10-12-13-14MM
- 1-BIT COUPLE 1/4"DR X 1/4"BIT
- 1-RATCHET HANDLE
- 1-UNIVERSAL JOINT
- 1-EXTENSION BAR 100MM
- 1-MULTI-SPANNER HANDLE
- 22-BIT 4-PH:0-1-2-3 3-PZ:1-2-3 4-SL:3-4-5-5-7 6-HEX:2-3-4-5-6-7
- 5-TX:T10-T15-T20-T25-T30
- 1/2"DR.
- 13-SOCKET 10-11-12-13-14-15-17-19-22-24-27-30-32MM
- 2-SPARK PLUG SOCKET 16MM - 21MM
- 1-RATCHET HANDLE
- 1-UNIVERSAL JOINT
- 1-EXTENSION BAR 125MM
- 8-COMBINATION WRENCH 10-11-12-13-14-15-17-19MM
- 3-HEX KEY WRENCH 1.5-2-2.5MM
- 1-COMBINATION PLIER
- 1-WATER PUMP PLIER
- 1-CRIMPING PLIER
- 5-SCREWDRIVER PH:6X40 , PH:6X100 , SL:6X40 , SL:6X100 , SL:8X200
- 1-HAMMER 300G
- 1-AUTO TESTER
- 26-TERMINALS

** MOQ: 300 SETS **

KA-T472-BS 72pcs 1/4" & 1/2" Dr. Hand Tool Set

Contents:

- 1-BLOW MOLD CASE
- 1/4"DR.
- 10-SOCKET 4-5-6-7-8-9-10-11-12-13MM
- 5-DEEP SOCKET 5-6-7-8-9MM
- 1-BIT COUPLE 1/4"DR X 1/4"BIT
- 1-RATCHET HANDLE
- 1-UNIVERSAL JOINT
- 1-EXTENSION BAR 75MM
- 1-MULTI-SPANNER HANDLE
- 14-BIT 3-PH:1-2-3 4-SL:3-4-5-6 7-TX:T10-T15-T20-T25-T27-T30-T40
- 1/2"DR.
- 13-SOCKET 10-11-12-13-14-15-17-19-22-24-27-30-32MM
- 2-SPARK PLUG SOCKET 16MM - 21MM
- 1-RATCHET HANDLE
- 1-UNIVERSAL JOINT
- 1-EXTENSION BAR 125MM
- 8-COMBINATION WRENCH 10-11-12-13-14-15-17-19MM
- 3-HEX KEY WRENCH 1.5-2-2.5MM
- 1-LOCKING PLIER
- 1-COMBINATION PLIER
- 1-WATER PUMP PLIER
- 5-SCREWDRIVER PH:6X40 , PH:6X100 , PZ:8X200 , SL:6X40 , SL:6X100
- 1-HAMMER 300G

** MOQ: 300 SETS **



KA-T499-BS 99pcs 1/4" & 1/2" Dr. Hand Tool Set

Contents:

- 1-BLOW MOLD CASE
- 1/4"DR.
- 10-SOCKET:4-5-6-7-8-9-10-11-12-13MM
- 5-DEEP SOCKET:9-10-11-12-13MM
- 1-BIT COUPLE 1/4"DR X 1/4"BIT
- 1-RATCHET HANDLE
- 1-UNIVERSAL JOINT
- 1-EXTENSION BAR 75 MM
- 1-MULTI-SPANNER HANDLE
- 14-BIT 3-PH:1-2-3 4-SL:3-4-5-6 5-HEX:3-4-5-6-7 2-TX:T20-T30
- 1/2"DR.
- 13-SOCKET 10-11-12-13-14-15-17-19-22-24-27-30-32MM
- 2-SPARK PLUG SOCKET 16MM - 21MM
- 1-RATCHET HANDLE
- 1-UNIVERSAL JOINT
- 1-EXTENSION BAR 125MM
- 8-COMBINATION WRENCH:10-11-12-13-14-15-17-19 MM
- 3-HEX KEY WRENCH:1.5-2-2.5 MM
- 1-COMBINATION PLIER
- 1-WATER PUMP PLIER
- 1-CRIMPING PLIER
- 5-SCREWDRIVER PH:6X40 , PH:6X100 , SL:6X40 , SL:6X100 , SL:8X200
- 1-HAMMER 300G
- 1-AUTO TESTER
- 26-TERMINALS

** MOQ: 300 SETS **





KA-S224A-BS 24pcs 1/4" Dr. Socket Set

Contents:

- 1-BLOW MOLD CASE
1/4"DR.
- 13-SOCKET:4-4.5-5-5.5-6-7-8-9-10-11-12-13-14MM
- 1-RATCHET HANDLE
- 1-UNIVERSAL JOINT
- 1-SLIDING T-BAR
- 2-EXTENSION BAR 50MM - 100MM
- 1-FLEXIBLE EXTENSION BAR 150MM
- 1-MULTI-SPANNER HANDLE
- 4-HEX KEY WRENCH:1.27-1.5-2-2.5MM

** MOQ: 300 SETS **



KA-S236-BS 36pcs 1/4" Dr. Socket Set

Contents:

- 1-BLOW MOLD CASE
1/4"DR.
- 10-SOCKET 4-5-5.5-6-7-8-10-11-12-13MM
- 6-DEEP SOCKET 6-7-8-10-12-13MM
- 1-BIT COUPLE 1/4"DR X 1/4"BIT
- 1-RATCHET HANDLE
- 1-UNIVERSAL JOINT
- 2-EXTENSION BAR 50MM - 100MM
- 11-BIT 2-PH1-2 2-PZ:1-2 2-SL:4-5.5 2-HEX:5-6 3-TX:T10-T15-T20
3/8"DR.
- 1-MULTI-ADAPTOR 3/8" F X 1/4" M
- 3-HEX KEY WRENCH 1.5-2-2.5MM

** MOQ: 300 SETS **



KA-S246B-BS 46pcs 1/4" Dr. Socket Set

Contents:

- 1-BLOW MOLD CASE
1/4"DR.
- 13-SOCKET:4-4.5-5-5.5-6-7-8-9-10-11-12-13-14MM
- 1-RATCHET HANDLE
- 1-UNIVERSAL JOINT
- 1-SLIDING T-BAR
- 2-EXTENSION BAR 50MM - 100MM
- 1-FLEXIBLE EXTENSION BAR 150MM
- 1-MULTI-SPANNER HANDLE
- 22-BIT SOCKET 3-PH:1-2-3 3-PZ:1-2-3 3-SL:4-4.5-6 6-HEX:3-4-5-6-7-8
7-TX:T8-T10-T15-T20-T25-T30-T40
- 4-HEX KEY WRENCH:1.27-1.5-2-2.5MM

** MOQ: 300 SETS **



KA-S247-BS 47pcs 1/4" Dr. Socket Set

Contents:

- 1-BLOW MOLD CASE
1/4"DR.
- 12- SOCKET 4-4.5-5-5.5-6-7-8-9-10-11-12-13MM
- 7-STAR SOCKET 4-5-6-7-8-10-11MM
- 1-RATCHET HANDLE
- 1-UNIVERSAL JOINT
- 1-SLIDING T-BAR
- 2-EXTENSION BAR 50MM - 100MM
- 1-MULTI-SPANNER HANDLE
- 18-BIT SOCKET 3-PH:1-2-3 3-SL:4-5.5-7 6-HEX:3-4-5-6-7-8
6-TX:T10-T15-T20-T25-T30-T40
- 4-HEX KEY WRENCH:1.27-1.5-2-2.5MM

** MOQ: 300 SETS **



KA-S217E-BS1 17pcs 1/4" Dr. Socket Set

- Contents:**
 1-BLOW MOLD CASE
 1/4"DR.
 12-SOCKET 4-4.5-5-5.5-6-7-8-9-10-11-12-13 MM
 1-RATCHET HANDLE
 1-UNIVERSAL JOINT
 1-SLIDING T-BAR
 1-EXTENSION BAR 50MM
 1-MULTI-SPANNER HANDLE

** MOQ: 300 SETS **



KA-S226A-BS1 26pcs 1/4" Dr. Socket Set

- Contents:**
 1-BLOW MOLD CASE
 1/4"DR.
 13-SOCKET:4-4.5-5-5.5-6-7-8-9-10-11-12-13-14MM
 1-BIT COUPLE 1/4"DR X 1/4"BIT
 1-RATCHET HANDLE
 1-UNIVERSAL JOINT
 1-SLIDING T-BAR
 2-EXTENSION BAR 50MM - 100MM
 1-FLEXIBLE EXTENSION BAR 150MM
 1-MULTI-SPANNER HANDLE
 3/8"DR
 1-SOCKET ADAPTOR 3/8" F X 1/4" M
 4-HEX KEY WRENCH 1.27-1.5-2-2.5MM

** MOQ: 300 SETS **



KA-S248A-BS1 48pcs 1/4" Dr. Socket Set

- Contents:**
 1-BLOW MOLD CASE
 1/4"DR
 13-SOCKET:4-4.5-5-5.5-6-7-8-9-10-11-12-13-14MM
 1-BIT COUPLE 1/4"DR X 1/4"BIT
 1-RATCHET HANDLE
 1-UNIVERSAL JOINT
 1-SLIDING T-BAR
 2-EXTENSION BAR 50MM - 100MM
 1-FLEXIBLE EXTENSION BAR 150MM
 1-MULTI-SPANNER HANDLE
 22-BIT SOCKET 3-PH:1-2-3 3-PZ:1-2-3 3-SL:4-5.5-7 6-HEX:3-4-5-6-7-8
 7-TX:T8-T10-T15-T20-T25-T30-T40
 3/8"DR
 1-SOCKET ADAPTOR 3/8" F X 1/4" M
 4-HEX KEY WRENCH 1.27-1.5-2-2.5MM

** MOQ: 300 SETS **



KA-S258A-BS1 58pcs 1/4" Dr. Socket Set

- Contents:**
 1-BLOW MOLD CASE
 1/4"DR
 12- SOCKET 4-4.5-5-5.5-6-7-8-9-10-11-12-13MM
 1-BIT COUPLE 1/4"DR X 1/4"BIT
 1-RATCHET HANDLE
 1-UNIVERSAL JOINT
 1-SLIDING T-BAR
 1-EXTENSION BAR 50MM
 1-MULTI-SPANNER HANDLE
 40-BIT 5-PH:0-1-2-2-3 5-PZ:0-1-2-2-3 10-SL:2.5-3-4-4.5-5-5.5-6-6.5-7-8
 10-HEX:1.5-2-2.5-3-4-5-5.5-6-7-8
 10-TX:T7-T8-T10-T15-T20-T25-T27-T30-T35-T40

** MOQ: 300 SETS **



KA-S327-BS 27pcs 3/8" Dr. Socket Set

- Contents:**
 1-BLOW MOLD CASE
 3/8"DR.
 18-SOCKET 6-7-8-9-10-11-12-13-14-15-16-17-19-20-21-22-24MM
 2-SPARK PLUG SOCKET 16MM - 21MM
 1-RATCHET HANDLE
 1-UNIVERSAL JOINT
 3-EXTENSION BAR 43MM - 75MM - 250MM
 1/2"DR.
 1-MULTI-ADAPTOR 1/2" F X 3/8" M

** MOQ: 300 SETS **



KA-S334A-BS 34pcs 3/8" Dr. Socket Set

- Contents:**
 1-BLOW MOLD CASE
 3/8"DR.
 18-SOCKET 6-7-8-9-10-11-12-13-14-15-16-17-18-19-20-21-22-24MM
 9-DEEP SOCKET 8-10-11-12-13-14-15-17-19MM
 2-SPARK PLUG SOCKET 16MM - 21MM
 1-RATCHET HANDLE
 1-UNIVERSAL JOINT
 2-EXTENSION BAR 75MM - 250MM
 1/2"DR.
 1-SOCKET ADAPTOR 1/2" F X 3/8" M

** MOQ: 300 SETS **



KA-S361-BS 61pcs 3/8" Dr. Socket Set

- Contents:**
 1-BLOW MOLD CASE
 3/8"DR.
 18-SOCKET 6-7-8-9-10-11-12-13-14-15-16-17-18-19-20-21-22-24MM
 9- DEEP SOCKET 8-10-11-12-13-14-15-17-19 MM
 2-SPARK PLUG SOCKET 16MM - 21MM
 1-RATCHET HANDLE
 1-UNIVERSAL JOINT
 3-EXTENSION BAR 75MM - 150MM - 250MM
 26-BIT SOCKET 3-PH:1-2-3 3-PZ:1-2-3 3-SL:5.5-7-8 7-HEX:3-4-5-6-7-8-10
 10-TX:T10-T15-T20-T25-T27-T30-T40-T45-T50-T55
 1/2"DR.
 1-MULTI-SOCKET ADAPTOR 1/2" F X 3/8" M

** MOQ: 300 SETS **



KA-S330A-BS1 30pcs 3/8" Dr. Socket Set

- Contents:**
 1-BLOW MOLD CASE
 3/8"DR.
 18-SOCKET 6-7-8-9-10-11-12-13-14-15-16-17-18-19-20-21-22-24 MM
 6-DEEP SOCKET 8-9-10-12-13-14 MM
 2-SPARK PLUG SOCKET 16MM - 21MM
 1-RATCHET HANDLE
 1-UNIVERSAL JOINT
 2-EXTENSION BAR 75MM-150MM

** MOQ: 300 SETS **



KA-S349A-BS1 39pcs 3/8" Dr. Socket Set

Contents:

- 1-BLOW MOLD CASE
- 1/4"DR.
- 1-BIT COUPLE 1/4"DR X 1/4"BIT
- 1-MULTI-SPANNER HANDLE
- 22- BIT 4-PH:0-1-2-3 3-PZ:1-2-3 4-SL:3-4-5-5-7 6-HEX:2-3-4-5-6-7
- 5-TX:T10-T15-T20-T25-T30
- 3/8"DR.
- 17-SOCKET 6-7-8-9-10-11-12-13-14-15-16-17-18-19-20-21-22 MM
- 2-SPARK PLUG SOCKET 16MM - 21MM
- 1-BIT COUPLE 3/8"DR X 1/4"BIT
- 1-RATCHET HANDLE
- 1-UNIVERSAL JOINT
- 2-EXTENSION BAR 75MM - 150MM
- 1-SOCKET ADAPTOR 3/8" F x 1/4" M

** MOQ: 300 SETS **



KA-S421-BS 21pcs 1/2" Dr. Socket Set

Contents:

- 1-BLOW MOLD CASE
- 3/8"DR.
- 1-MULTI-ADAPTOR 3/8" F X 1/2" M
- 1/2"DR..
- 16- SOCKET 10-11-12-13-14-15-16-17-18-19-21-22-24-27-30-32MM
- 1-RATCHET HANDLE
- 1-UNIVERSAL JOINT
- 2-EXTENSION BAR 75MM - 125MM

** MOQ: 300 SETS **



KA-S472-BS 72pcs 1/4" & 1/2" Dr. Socket Set

Contents:

- 1-BLOW MOLD CASE
- 1/4"DR.
- 10-SOCKET 4-5-5.5-6-7-8-10-11-12-13MM
- 1-BIT COUPLE 1/4"DR X 1/4"BIT
- 1-RATCHET HANDLE
- 1-EXTENSION BAR 100MM
- 1-MULTI-SPINNER HANDLE
- 33-BIT 4-PH:0-1-2-3 4-HEX:3-4-5-6 4-TX:T8-T10-T15-T20
- 4-HEX:1/8"-9/64"-5/32"-3/16" 2-HEX:8-10 2-SP:6-8MM
- 4-TX:T25-T27-T30-T40 3-HEX:7/32"-1/4"-5/16" 3-SPR:4-5.5-7 3-PZ:1-2-3
- 3/8"DR.
- 1-MULTI-ADAPTOR 3/8" F X 1/2" M
- 1/2"DR.
- 16-SOCKET 10-11-12-13-14-15-16-17-18-19-20-21-22-23-24-27MM
- 1-SPARK PLUG SOCKET 21MM
- 1-RATCHET HANDLE
- 1-UNIVERSAL JOINT
- 1-EXTENSION BAR 125MM - 250MM
- 3-HEX KEY WRENCH 1.5-2-2.5MM

** MOQ: 300 SETS **



KA-S472A-BS 72pcs 1/4" & 1/2" Dr. Socket Set

Contents:

- 1-BLOW MOLD CASE
- 1/4"DR.
- 9 -SOCKET 4-5-6-7-8-9-10-11-12MM
- 1- BIT COUPLE 1/4"DR X 1/4"BIT
- 1-RATCHET HANDLE
- 2-EXTENSION BAR 50MM - 100MM
- 1/4"(6.4MM) BIT
- 40-BIT 5-PH:0-1-2-2-3 5-PZ:0-1-2-2-3 10-SL:2.5-3-4-4.5-5-5.5-6-6.5-7-8
- 10-HEX:1.5-2-2.5-3-4-5-5.5-6-7-8
- 10-TX:T7-T8-T10-T15-T20-T25-T27-T30-T35-T40
- 1/2"DR.
- 9-SOCKET 13-14-15-16-17-19-21-22-24MM
- 1-RATCHET HANDLE
- 1-UNIVERSAL JOINT
- 1-EXTENSION BAR 125MM
- 7-COMBINATION WRENCH 10-11-12-13-14-15-17MM

** MOQ: 300 SETS **

KA-S494-BS 94pcs 1/4" & 1/2" Dr. Socket Set

Contents:

- 1-BLOW MOLD CASE
- 1/4"DR
- 13-SOCKET 4-4.5-5-5.5-6-7-8-9-10-11-12-13-14MM
- 8-DEEP SOCKET 6-7-8-9-10-11-12-13MM
- 1-RATCHET HANDLE
- 1-UNIVERSAL JOINT
- 1-SLIDING T-BAR
- 2-EXTENSION BAR 50MM-100MM
- 1-FLEXIBLE EXTENSION BAR 150MM
- 1-MULTI-SPANNER HANDLE
- 1-BIT ADAPTOR 30L
- 17-BIT SOCKET 2-PH:1-2 2-PZ:1-2 3-SL:4-5.5-7 4-H:3-4-5-6
6-TX:T8-T10-T15-T20-T25-T30
- 3/8"DR
- 1-MULTI-ADAPTOR 3/8"F x 1/2"M
- 5/16"(8MM) BIT
- 15-BIT 2-PH:3-4 2-PZ:3-4 3-SL: 8-10-12 4-H:8-10-12-14 4-TX:T40-T45-T50-T55
- 1/2"DR.
- 18-SOCKET 10-11-12-13-14-15-16-17-18-19-20-21-22-23-24-27-30-32MM
- 4-DEEP SOCKET 14-15-17-19MM
- 2-SPARK PLUG SOCKET 16MM - 21MM
- 1-BIT COUPLE 1/2"DR X 5/16"BIT
- 1-RATCHET HANDLE
- 1-UNIVERSAL JOINT
- 2-EXTENSION BAR 125MM - 250MM
- 3-HEX KEY WRENCH 1.5-2-2.5MM

** MOQ: 300 SETS **



KA-S4108-BS 108pcs 1/4" & 1/2" Dr. Socket Set

Contents:

- 1-BLOW MOLD CASE
- 1/4"DR.
- 13- SOCKET 4-4.5-5-5.5-6-7-8-9-10-11-12-13-14 MM
- 8-DEEP SOCKET 6-7-8-9-10-11-12-13MM
- 5-STAT SOCKET E4-E5-E6-E7-E8
- 1-RATCHET HANDLE
- 1-UNIVERSAL JOINT
- 1-SLIDING T-BAR
- 2-EXTENSION BAR 50MM - 100MM
- 1-MULTI-SPINNER HANDLE
- 18-BIT SOCKET 2-PH:1-2 2-PZ:1-2 3-SL:4-5.5-6.5 4-HEX:3-4-5-6
7-TX:T8-10-15-20-25-27-30
- 3/8"DR
- 1-MULTI-ADAPTOR 3/8" F X 1/2" M
- 5/16"(8MM) BIT
- 16-BIT 2-PH:3-4 2-PZ:3-4 3-SL:8-10-12 5-HEX :7-8-10-12-14
4-TX:T40-45-50-55
- 1/2"DR
- 17-SOCHET 10-11-12-13-14-15-16-17-18-19-20-21-22-24-27-30-32MM
- 5-DEEP SOCKET 14-15-17-19-22MM
- 8-STAR SOCKET E10-E11-E12-E14-E16-E18-E20-E24
- 2-SPARK PLUG SOCKET 16MM - 21MM
- 1-BIT COUPLE 1/2"DR X 5/16"BIT
- 1-RATCHET HANDLE
- 1-UNIVERSAL JOINT
- 2-EXTENSION BAR 125MM - 250MM
- 3-HEX KEY WRENCH 1.5-2-2.5 MM

** MOQ: 300 SETS **



KA-S4108B-BS 108pcs 1/4" & 1/2" Dr. Socket Set

Contents:

- 1-BLOW MOLD CASE
- 1/4"DR
- 13-SOCKET 4-4.5-5-5.5-6-7-8-9-10-11-12-13-14MM
- 8-DEEP SOCKET 6-7-8-9-10-11-12-13MM
- 5-STAR SOCKET E4-E5-E6-E7-E8
- 1-RATCHET HANDLE
- 1-UNIVERSAL JOINT
- 1-SLIDING T-BAR
- 2-EXTENSION BAR 50MM - 75MM
- 1-MULTI-SPINNER HANDLE
- 18-BIT SOCKET 2-PH:1-2 2-PZ:1-2 3-SL:4-5.5-6.5 4-HEX:3-4-5-6
7-TX:T8-T10-T15-T20-T25-T27-T30
- 3/8"DR
- 1-MULTI-ADAPTOR 3/8" F X 1/2" M
- 5/16"(8M/M) BIT
- 17-BIT 2-PH:3-4 2-PZ:3-4 3-SL:8-10-12 5-HEX:7-8-10-12-14
5-TX:40-45-50-55-60
- 1/2"DR.
- 17-SOCKET 10-11-12-13-14-15-16-17-18-19-20-21-22-24-27-30-32MM
- 5-DEEP SOCKET 14-15-17-19-22MM
- 8-STAR SOCKET E10-E11-E12-E14-E16-E18-E20-E24
- 2-SPARK PLUG SOCKET 16MM - 21MM
- 1-BIT COUPLE 1/2"DR X 5/16"BIT
- 1-RATCHET HANDLE
- 1-UNIVERSAL JOINT
- 2-EXTENSION BAR 125MM - 250MM
- 3-HEX KEY WRENCH 1.5-2-2.5MM

** MOQ: 300 SETS **



KA-S497A-BS1 97pcs 1/4" & 1/2" Dr. Socket Set

Contents:

- 1-BLOW MOLD CASE
- 1/4"DR
- 13-SOCKET 4-4.5-5-5.5-6-7-8-9-10-11-12-13-14MM
- 8-DEEP SOCKET 6-7-8-9-10-11-12-13MM
- 1-RATCHET HANDLE
- 1-UNIVERSAL JOINT
- 1-SLIDING T-BAR
- 2-EXTENSION BAR 50MM - 100MM
- 1-FLEXIBLE EXTENSION BAR 150MM
- 1-MULTI-SPANNER HANDLE
- 18-BIT SOCKET 2-PH:1-2 2-PZ:1-2 3-SL:4-5.5-7 4-HEX:3-4-5-6
7-TX:T8-T10-T15-T20-T25-T27-T30
- 3/8"DR
- 1-MULTI-ADAPTOR 3/8" F X 1/2" M
- 5/16"(8MM) BIT
- 16-BIT 2-PH:3-4 2-PZ:3-4 3-SL: 8-10-12 4-HEX:8-10-12-14
5-TX:T30-T40-T45-T50-T55
- 1/2"DR.
- 20-SOCKET 8-9-10-11-12-13-14-15-16-17-18-19-20-21-22-23-24-27-30-32MM
- 4-DEEP SOCKET 14-15-17-19MM
- 2-SPARK PLUG SOCKET 16MM - 21MM
- 1-BIT COUPLE 1/2"DR X 5/16"BIT
- 1-RATCHET HANDLE
- 1-UNIVERSAL JOINT
- 2-EXTENSION BAR 125MM - 250MM
- 3-HEX KEY WRENCH 1.5-2-2.5MM

** MOQ: 300 SETS **



KA-S4111A-BS1 111pcs 1/4" & 1/2" Dr. Socket Set



- Contents:**
 1-BLOW MOLD CASE
 1/4"DR.
 13-SOCKET 4-4.5-5-5.5-6-7-8-9-10-11-12-13-14MM
 8-DEEP SOCKET 6-7-8-9-10-11-12-13MM
 5-STAR SOCKET E4-E5-E6-E7-E8
 1-RATCHET HANDLE
 1-UNIVERSAL JOINT
 1-SLIDING T-BAR
 2-EXTENSION BAR 50MM - 100MM
 1-MULTI-SPANNER HANDLE
 18-BIT SOCKET 2-PH:1-2 2-PZ:1-2 3-SL:4-5-5-7 4-HEX:3-4-5-6
 7-TX:T8-T10-T15-T20-T25-T27-T30
 3/8"DR.
 1-MULTI-ADAPTOR 3/8" F X 1/2" M
 5/16"(8M/M) BIT
 16-BIT 2-PH:3-4 2-PZ:3-4 3-SL:8-10-12 4-HEX:8-10-12-14
 5-TX:T30-T40-T45-T50-T55
 1/2"DR..
 20-SOCKET 8-9-10-11-12-13-14-15-16-17-18-19-20-21-22-23-24-27-30-32MM
 5-DEEP SOCKET 14-15-17-19-22MM
 8-STAR SOCKET E10-E11-E12-E14-E16-E18-E20-E24
 2-SPARK PLUG SOCKET 16MM - 21MM
 1-BIT COUPLE 1/2"DR X 5/16"BIT
 1-RATCHET HANDLE
 1-UNIVERSAL JOINT
 2-EXTENSION BAR 125MM - 250MM
 4-HEX KEY WRENCH 1.27-1.5-2-2.5MM

** MOQ: 300 SETS **

KA-S4124A-BS1 124pcs 1/4" & 1/2" Dr. Socket Set



- Contents:**
 1-BLOW MOLD CASE
 1/4"DR.
 13-SOCKET 4-4.5-5-5.5-6-7-8-9-10-11-12-13-14MM
 8-DEEP SOCKET 6-7-8-9-10-11-12-13MM
 1- BIT COUPLE 1/4"DR X 1/4"BIT
 1 -RATCHET HANDLE
 1 -UNIVERSAL JOINT
 1 -SLIDING T-BAR
 1 -EXTENSION BAR 50MM
 1 -MULTI-SPANNER HANDLE
 1/4"(6.4MM) BIT
 40-BIT 5-PH:0-1-2-2-3 5-PZ:0-1-2-2-3 10-SL:2.5-3-4-4.5-5-5.5-6-6.5-7-8
 10-HEX:1.5-2-2.5-3-4-5-5.5-6-7-8
 10-TX:T7-T8-T10-T15-T20-T25-T27-T30-T35-T40
 3/8"DR.
 1 -MULTI-ADAPTOR 3/8" F X 1/4" M
 1 -MULTI-ADAPTOR 3/8" F X 1/2" M
 5/16"(8MM) BIT
 16-BIT 2-PH:3-4 2-PZ:3-4 3-SL:8-10-12 5-HEX:7-8-10-12-14
 4-TX:T40-T45-T50-T55
 1/2"DR.
 13-SOCKET 15-16-17-18-19-20-21-22-23-24-27-30-32MM
 4 -DEEP SOCKET 14-15-17-19MM
 2 -SPARK PLUG SOCKET 16MM - 21MM
 1- BIT COUPLE 1/2"DR X 5/16"BIT
 1 -RATCHET HANDLE
 1 -UNIVERSAL JOINT
 2 -EXTENSION BAR 125MM - 250MM
 6 -COMBINATION WRENCH 8-10-12-13-15-17MM
 9 -HEX KEY 1.5-2-2.5-3-4-5-6-8-10MM

** MOQ: 300 SETS **

KA-S447A-BD1 47pcs 1/2" Dr. Socket Set



- Contents:**
 1-BLOW MOLD CASE
 3/8"DR.
 1-MULTI-ADAPTOR 3/8" F X 1/2" M
 5/16"(8MM) BIT
 14-BIT: 2-PH:3-4 2-PZ:3-4 2-SL:8-10 3-HEX:10-12-14 5-TX:T40-T45-T50-T55-T60
 1/2"DR.
 15-SOCKET 10-11-12-13-14-15-17-18-19-20-22-24-27-30-32MM
 5-DEEP SOCKET 14-15-17-19-22 MM
 2-SPARK PLUG SOCKET 16MM - 21MM
 1-BIT COUPLE 1/2"DR X 5/16"BIT
 1-RATCHET HANDLE
 1-UNIVERSAL JOINT
 2-EXTENSION BAR 125MM - 250MM
 4-HEX KEY WRENCH 1.27-1.5-2-2.5MM

** MOQ: 300 SETS **



KA-S447F-BD1 47pcs 1/2" Dr. Socket Set and Flexible Ratchet

Contents:

- 1-BLOW MOLD CASE
- 3/8"DR
- 1-MULTI-ADAPTOR 3/8" F X 1/2" M
- 5/16"(8MM) BIT
- 14-BIT: 2-PH:3-4 2-PZ:3-4 2-SL:8-10 3-HEX:10-12-14 5-TX:T40-T45-T50-T55-T60
- 1/2"DR
- 15-SOCKET 10-11-12-13-14-15-17-18-19-20-22-24-27-30-32MM
- 5-DEEP SOCKET 14-15-17-19-22 MM
- 2-SPARK PLUG SOCKET 16MM - 21MM
- 1-BIT COUPLE 1/2"DR X 5/16"BIT
- 1-FLEXIBLE RATCHET HANDLE
- 1-UNIVERSAL JOINT
- 2-EXTENSION BAR 125MM - 250MM
- 4-HEX KEY WRENCH 1.27-1.5-2-2.5MM

** MOQ: 300 SETS **

KA-S489A-BD1 89pcs 1/4" & 1/2" Dr. Socket Set

Contents:

- 1-BLOW MOLD CASE
- 1/4"DR.
- 9-SOCKET 4-4.5-5-5.5-6-7-8-9-10MM
- 5-STAR SOCKET E4-E5-E6-E7-E8
- 1-BIT COUPLE 1/4"DR X 1/4"BIT
- 1-RATCHET HANDLE
- 1-UNIVERSAL JOINT
- 1-EXTENSION BAR 150MM
- 1/4"(6.4MM) BIT
- 20-BIT 5-PH:0-1-2-2-3 5-PZ:0-1-2-2-3
- 10-TX:T7-T8-T10-T15-T20-T25-T27-T30-T35-T40
- 3/8"DR.
- 1-MULTI-ADAPTOR 3/8" F X 1/2" M
- 5/16"(8MM) BIT
- 16-BIT 2-PH:3-4 2-PZ:3-4 3-SL:8-10-12 5-HEX:7-8-10-12-14
- 4-TX:T40-T45-T50-T55
- 1/2"DR.
- 17-SOCKET 10-11-12-13-14-15-16-17-18-19-20-21-22-24-27-30-32MM
- 8-STAR SOCKET E10-E11-E12-E14-E16-E18-E20-E24
- 1-BIT COUPLE 1/2"DR X 5/16"BIT
- 1-RATCHET HANDLE
- 1-UNIVERSAL JOINT
- 2-EXTENSION BAR 125MM - 250MM
- 4-HEX KEY 1.27-1.5-2-2.5MM

** MOQ: 300 SETS **

KA-S4101A-BD1 101pcs 1/4" & 1/2" Dr. Socket Set

Contents:

- 1-BLOW MOLD CASE
- 1/4"DR.
- 13-SOCKET 4-4.5-5-5.5-6-7-8-9-10-11-12-13-14MM
- 1-BIT COUPLE 1/4"DR X 1/4"BIT
- 1-RATCHET HANDLE
- 1-UNIVERSAL JOINT
- 1-MULTI-SPANNER HANDLE
- 1/4"(6.4MM) BIT
- 40-BIT 5-PH:0-1-2-2-3 5-PZ:0-1-2-2-3
- 10-SL:2.5-3-4-4.5-5-5.5-6-6.5-7-8
- 10-HEX:1.5-2-2.5-3-4-5-5.5-6-7-8
- 10-TX:T7-T8-T10-T15-T20-T25-T27-T30-T35-T40
- 3/8"DR.
- 1-MULTI-ADAPTOR 3/8" F X 1/2" M
- 5/16"(8MM) BIT
- 16-BIT 2-PH:3-4 2-PZ:3-4 3-SL:8-10-12 5-HEX:7-8-10-12-14
- 4-TX:T40-T45-T50-T55
- 1/2"DR.
- 13-SOCKET 15-16-17-18-19-20-21-22-23-24-27-30-32MM
- 1-BIT COUPLE 1/2"DR X 5/16"BIT
- 1-RATCHET HANDLE
- 1-UNIVERSAL JOINT
- 2-EXTENSION BAR 125MM - 250MM
- 9-HEX KEY 1.5-2-2.5-3-4-5-6-8-10MM

** MOQ: 300 SETS **



KA-S4100A-BD1 100pcs 1/4" & 1/2" Dr. Socket Set

Contents:

- 1-BLOW MOLD CASE
- 1/4"DR.
- 9 -SOCKET 4-4.5-5-5.5-6-7-8-9-10MM
- 5 -STAR SOCKET E4-E5-E6-E7-E8
- 1- BIT COUPLE 1/4"DR X 1/4" BIT
- 1 -RATCHET HANDLE
- 1 -UNIVERSAL JOINT
- 1 -EXTENSION BAR 150MM
- 1/4"(6.4MM) BIT
- 20-BIT 5-PH:0-1-2-2-3 5-PZ:0-1-2-2-3
- 10-TX:T7-T8-T10-T15-T20-T25-T27-T30-T35-T40
- 3/8"DR.
- 1 -MULTI -ADAPTOR 3/8" F X 1/2" M
- 5/16"(8MM) BIT
- 16-BIT 2-PH:3-4 2-PZ:3-4 3-SL:8-10-12 5-HEX:7-8-10-12-14
- 4-TX:T40-T45-T50-T55
- 1/2"DR.
- 17-SOCKET 10-11-12-13-14-15-16-17-18-19-20-21-22-24-27-30-32MM
- 8-STAR SOCKET E10-E11-E12-E14-E16-E18-E20-E24
- 1- BIT COUPLE 1/2"DR X 5/16" BIT
- 1-RATCHET HANDLE
- 1-UNIVERSAL JOINT
- 2-EXTENSION BAR 125MM - 250MM
- 11-COMBINATION WRENCH 8-9-10-11-12-13-14-15-17-19-22MM
- 4-HEX KEY 1.27-1.5-2-2.5MM

** MOQ: 300 SETS **



KA-S4112A-BD1 112pcs 1/4" & 1/2" Dr. Socket Set

Contents:

- 1-BLOW MOLD CASE
- 1/4"DR.
- 13-SOCKET 4-4.5-5-5.5-6-7-8-9-10-11-12-13-14MM
- 1- BIT COUPLE 1/4"DR X 1/4"BIT
- 1 -RATCHET HANDLE
- 1 -UNIVERSAL JOINT
- 1 -MULTI-SPANNER HANDLE
- 1/4"(6.4MM) BIT
- 40-BIT 5-PH:0-1-2-2-3 5-PZ:0-1-2-2-3 10-SL:2.5-3-4-4.5-5-5.5-6-6.5-7-8
- 10-HEX:1.5-2-2.5-3-4-5-5.5-6-7-8
- 10-TX:T7-T8-T10-T15-T20-T25-T27-T30-T35-T40
- 3/8"DR.
- 1 -MULTI ADAPTOR 3/8" F X 1/2" M
- 5/16"(8MM) BIT
- 16-BIT 2-PH:3-4 2-PZ:3-4 3-SL:8-10-12 5-HEX:7-8-10-12-14
- 4-TX:T40-T45-T50-T55
- 1/2"DR.
- 13-SOCKET 15-16-17-18-19-20-21-22-23-24-27-30-32MM
- 1- BIT COUPLE 1/2"DR X 5/16"BIT
- 1 -RATCHET HANDLE
- 1 -UNIVERSAL JOINT
- 2 -EXTENSION BAR 125MM - 250MM
- 11-COMBINATION WRENCH 8-9-10-11-12-13-14-15-17-19-22MM
- 9 -HEX KEY 1.5-2-2.5-3-4-5-6-8-10MM

** MOQ: 300 SETS **



KA-S4112B-BD1 112pcs 1/4" & 1/2" Dr. Socket Set

Contents:

- 1-BLOW MOLD CASE
- 1/4"DR.
- 9 -SOCKET 4-4.5-5-5.5-6-7-8-9-10MM
- 8 -DEEP SOCKET 6-7-8-9-10-11-12-13MM
- 5 -STAR SOCKET E4-E5-E6-E7-E8
- 1 -BIT COUPLE 1/4"DR X 1/4"BIT
- 1 -RATCHET HANDLE
- 1 -UNIVERSAL JOINT
- 1 -SLIDING T-BAR
- 2 -EXTENSION BAR 50MM - 150MM
- 1/4"(6.4MM) BIT
- 20-BIT 5-PH:0-1-2-2-3 5-PZ:0-1-2-2-3
- 10-TX:T7-T8-T10-T15-T20-T25-T27-T30-T35-T40
- 3/8"DR.
- 1-MULTI ADAPTOR 3/8" F X 1/4" M
- 1-MULTI ADAPTOR 3/8" F X 1/2" M
- 5/16"(8MM) BIT
- 16-BIT 2-PH:3-4 2-PZ:3-4 3-SL:8-10-12 5-HEX:7-8-10-12-14
- 4-TX:T40-T45-T50-T55
- 1/2"DR.
- 17-SOCKET 10-11-12-13-14-15-16-17-18-19-20-21-22-24-27-30-32MM
- 4-DEEP SOCKET 14-15-17-19MM
- 8-STAR SOCKET E10-E11-E12-E14-E16-E18-E20-E24
- 2-SPARK PLUG SOCKET 16MM - 21MM
- 1-BIT COUPLE 1/2"DR X 5/16"BIT
- 1-RATCHET HANDLE
- 1-UNIVERSAL JOINT
- 2-EXTENSION BAR 125MM - 250MM
- 6-COMBINATION WRENCH 8-10-12-13-15-17MM
- 4-HEX KEY 1.27-1.5-2-2.5MM

** MOQ: 300 SETS **



KA-S4124A-BD1 124pcs 1/4" & 1/2" Dr. Socket Set

Contents:

- 1-BLOW MOLD CASE
- 1/4"DR.
- 13-SOCKET 4-4.5-5-5.5-6-7-8-9-10-11-12-13-14MM
- 8 -DEEP SOCKET 6-7-8-9-10-11-12-13MM
- 1 -BIT COUPLE 1/4"DR X 1/4"BIT
- 1 -RATCHET HANDLE
- 1 -UNIVERSAL JOINT
- 1 -SLIDING T-BAR
- 1 -EXTENSION BAR 50MM
- 1 -MULTI-SPANNER HANDLE
- 1/4"(6.4MM) BIT
- 40-BIT 5-PH:0-1-2-2-3 5-PZ:0-1-2-2-3 10-SL:2.5-3-4-4.5-5-5.5-6-6.5-7-8
- 10-HEX:1.5-2-2.5-3-4-5-5.5-6-7-8
- 10-TX:T7-T8-T10-T15-T20-T25-T27-T30-T35-T40
- 3/8"DR.
- 1 -MULTI-ADAPTOR 3/8"F X 1/4"M
- 1 -MULTI-ADAPTOR 3/8"F X 1/2"M
- 5/16"(8MM) BIT
- 16-BIT 2-PH:3-4 2-PZ:3-4 3-SL:8-10-12 5-HEX:7-8-10-12-14
- 4-TX:T40-T45-T50-T55
- 1/2"DR.
- 13-SOCKET 15-16-17-18-19-20-21-22-23-24-27-30-32MM
- 4 -DEEP SOCKET 14-15-17-19MM
- 2 -SPARK PLUG SOCKET 16MM - 21MM
- 1 -BIT COUPLE 1/2"DR X 5/16"BIT
- 1 -RATCHET HANDLE
- 1 -UNIVERSAL JOINT
- 2 -EXTENSION BAR 125MM - 250MM
- 6 -COMBINATION WRENCH 8-10-12-13-15-17MM
- 9 -HEX KEY 1.5-2-2.5-3-4-5-6-8-10MM

** MOQ: 300 SETS **





KA-S424B-BR1 24pcs 1/2" Dr. Super-Lock Socket Set

- Contents:**
 1-BLOW MOLD CASE
 1/2"DR
 18-SOCKET 10-11-12-13-14-15-16-17-18-19-20-21-22-23-24-27-30-32MM
 1-SPARK PLUG SOCKET 21MM
 1- RATCHET HANDLE
 1-UNIVERSAL JOINET
 1-SLIDING T-BAR
 2-EXTENSION BAR 125MM - 250MM

** MOQ: 300 SETS **

KA-S459A-BR1 59pcs 1/4" & 1/2" Dr. Socket Set

- Contents:**
 1-BLOW MOLD CASE
 1/4"DR
 13-SOCKET 4-4.5-5-5.5-6-7-8-9-10-11-12-13-14MM
 5-STAR SOCKET E4-E5-E6-E7-E8
 1-RATCHET HANDLE
 1-UNIVERSAL JOINET
 1-SLIDING T-BAR
 2-EXTENSION BAR 50MM - 100MM
 1-MULTI-SPINNER HANDLE
 3/8"DR
 1-MULTI ADAPTOR 3/8" F X 1/2" M
 1/2"DR
 17-SOCKET 10-11-12-13-14-15-16-17-18-19-20-21-22-24-27-30-32MM
 8 -STAR SOCKET E10-E11-E12-E14-E16-E18-E20-E24
 2-SPARK PLUG SOCKET 16MM - 21MM
 1-RATCHET HANDLE
 1-UNIVERSAL JOINET
 2-EXTENSION BAR 125MM - 250MM
 3-HEX KEY WRENCH 1.5-2-2.5MM

** MOQ: 300 SETS **



3/4" Dr. 21pcs Socket Wrench Set

KA-2319K (mm size)

- Contents :**
 16PC -12PT Socket:
 19, 21, 22, 23, 24, 26, 27, 29, 30,
 32, 35, 36, 38, 41, 46, 50mm
 1PC - 500mm Ratchet Handle
 1PC - 450mm Sliding Bar
 2PC - 100 & 200mm Extension Bar

KA-2320K (inch size)

- Contents :**
 16PC -12PT Socket:
 7/8, 15/16, 1, 1-1/16, 1-1/8,
 1-3/16, 1-1/4, 1-5/16, 1-3/8,
 1-7/16, 1-1/2, 1-5/8, 1-3/4,
 1-13/16, 1-7/8, 2"
 1PC - 20 Ratchet Handle
 1PC - 18 Sliding Bar
 2PC - 4 & 8 Extension Bar



1" Dr. 22pcs Socket Wrench Set

KA-2322K (mm size)

- Contents :**
 17PC -12PT Socket:
 36, 38, 41, 46, 46, 50, 54, 55, 58,
 60, 63, 65, 67, 70, 71, 75, 77mm
 1PC - Ratchet Head
 1PC - Sliding Head
 1PC - 22 Universal Handle
 2PC - 8 & 16 Extension Bar

KA-2323K (inch size)

- Contents :**
 17PC -12PT Socket:
 1-7/16, 1-1/2, 1-5/8, 1-11/16,
 1-3/4, 1-13/16, 1-7/8, 2, 2-1/8,
 2-3/16, 2-1/4, 2-3/8, 2-1/2, 2-5/8,
 2-3/4, 2-15/16, 3-1/8
 1PC - Ratchet Head
 1PC - Sliding Head
 1PC - 22 Universal Handle
 2PC -8 & 16 Extension Bar



KA-6027 27pcs 3/4" Dr. Socket Wrench Set

- Chrome vanadium steel
- Contents:
 - 1PC - 20" reversible Ratchet Handle
 - 1PC - 18" Silding "T" Bar
 - 1PC - 4" Extension Bar
 - 1PC - 8" Extension Bar
 - 1PC - Metal Box 21" x 7" x 3-1/16"
 - 12PC - 12pt. Sockets(inch size): 7/8", 15/16", 1", 1-1/8", 1-3/16", 1-5/16", 1-3/8", 1-7/16", 1-5/8", 1-3/4", 1-7/8", 2"
 - 10PC - 12pt. Sockets (metric size): 22, 24, 27, 30, 32, 36, 38, 41, 46, 50mm



KT-4043 43pcs 1/2" Dr. Socket Set

- Contents:
 - 33PC - 12pt. Socket: 10, 11, 12, 13, 14, 15, 16, 17, 18, 19, 20, 21, 22, 23, 24, 27, 30, 32mm
 - 3/8", 7/16", 1/2", 9/16", 5/8", 11/16", 3/4", 13/16", 7/8", 15/16", 1", 1-1/16", 1-1/8", 1-3/16", 1-1/4"
 - 1PC - Ratchet Handle
 - 2PC - Extension Bar 5" & 10"
 - 2PC - Spark Plug Socket 16mm & 21mm
 - 1PC - Sliding T Handle
 - 1PC - Universal Joint



KT-3039 39pcs 3/8" Dr. Socket Set

- Contents:
 - 9PC - 3/8" Dr. Socket x 12pt.(METRIC)
 - 9, 10, 11, 12, 13, 14, 16, 17, 19mm
 - 7PC - 3/8" Dr. Socket x 12pt (SAE)
 - 3/8", 7/16", 1/2", 9/16", 5/8", 11/16", 3/4"
 - 9PC - 1/4" Dr. Socket x 6pt (METRIC)
 - 4, 5, 6, 7, 8, 9, 10, 11, 12mm
 - 9PC - 1/4" Dr. Socket x 6pt (SAE)
 - 3/16", 7/32", 1/4", 9/32", 5/16", 11/32", 3/8", 7/16", 1/2"
 - 1PC - Spinner Handle
 - 1PC - Extension Bar 3"
 - 1PC - 3/8" x 1/4" Adapter
 - 1PC - 3/8" x 5/8" Spark Plug
 - 1PC - 3/8" Dr. Ratchet Handle



KA-2286K 56pcs 1/4" & 1/2" Drive Socket & Bit Set

- 12-1/4" Dr. Socket : 4, (4.5), 5, (5.5), 6, 7, 8, 9, 10, 11, 12, 13mm
- 13-1/2" Dr. Socket : 10, 11, 12, 13, 14, 15, 17, 19, 22, 24, 27, 30, 32mm
- 1-1/4" Dr. Quick Release Ratchet Handle
- 1-1/4" Dr. Universal Joint
- 1-1/4" Extension Bar 50mm
- 5-Hex Key : (1.25), (1.5), 2, (2.5), 3mm
- 2-1/2" Dr. Spark Plug Socket 16mm & 21mm
- 1-1/2" Dr. Universal Joint
- 1-1/2" Dr. Extension Bar 63mm
- 1-1/2" Dr. Extension Bar 250mm
- 1-3/8" (F) x 1/2" (M) T-Bar Adapter
- 1-1/4" Dr. Spinner Handle
- 1-1/4" Dr. Extension Bar 150mm
- 1-3/8" (F) x 1/4" (M) T-Bar Adapter
- 1-1/2" Dr. Quick Release Ratchet Handle
- 2-1/4" Dr. Phillips Bit Socket : #1, #2
- 2-1/4" Dr. Slotted Bit Socket : 4, (5.5)mm
- 3-1/4" Dr. Hex Bit Socket : 4, 5, 6mm
- 5-1/4" Dr. Torx Bit Socket : T-15, 20, 25, 27, 30
- 1-Metal box



KA-2291K 19pcs 1/4" & 1/2" Drive Bit Socket Set
 6-1/4" Dr. Torx Bit Socket 36mm : T-8, 10, 15, 20, 25, 27
 6-1/2" Dr. Torx. Bit Socket 55mm : T-30, 40, 45, 50, 55, 60
 6-1/2" Dr. Torx Bit socket 100mm : T-30, 40, 45, 50, 55, 60
 1-Metal Box



KA-2295K 7pcs 3/8" & 1/2" Drive Bit Socket Set
 4-3/8" Dr. Ribe Bit Socket 90mm : M6, M7, M8, M10
 3-1/2" Dr. Ribe Bit Socket 100mm : M12, M13, M14



KA-1174 33pcs Security Bits Set
 1-60mm Magnetic Bit Holder
 32-Bit 1/4"x25L:
 Torq: 6-8-10 & Spanner: 4-6-8-10 & Tri-Wing : 1-2-3-4
 Tamper Hex: 2-2.5-3-4-5-6-5/32"-9/64"-1/8"-7/64"-3/32"-5/64"
 Torx (W/Tamper) : T8-T10-T15T-20-T25-T27-T30-T35-T40



KA-1306 17pcs 1/2" Dr. Ribe Tip Power bit Set
 5- SPLINE BITS, 30MM EACH OF: M5-M6-M7-M8-M10
 5- SPLINE BITS, 75MM EACH OF: M5-M6-M7-M8-M10-M11-M12-M13-M14
 1- BIT ADAPTER: 1/2" X 10 mm



KA-1189 6pcs Adaptor Set
 1-1/4"(M) × 3/8"(F) ADAPTOR 1-3/8"(M) × 1/4"(F) ADAPTOR
 1-1/2"(M) × 3/8"(F) ADAPTOR 1-3/8"(M) × 1/2"(F) ADAPTOR
 1-3/4"(M) × 1/2"(F) ADAPTOR 1-1/2"(M) × 3/4"(F) ADAPTOR



KA-7359A T-Handle Hex Socket Wrench Set

SIZE: 8-10-13mm
(CR-V STEEL, HARDENED & SATIN CHROME PLATED)



KA-4176K 10pcs T-Handle Nut Drive 2/TO Approve Replace

1-SLIDING T BAR 200MM
9PC-NUT DRIVER 295MM
8-9-10-11-12-13-14-17-19 MM
PACKING: W/VINLY POUCH+COLOR BOX + SHRINK



KA-1619N Hex Key Wrench

- 7pcs: M4-M5-M6-M7-M8-M9-M10



KA-1629N Torx Wrench Set (L)

(two side with hold)

- 9pcs: T10-T15-T20-T25-T27-T30-T40-T45-T50



KA-3629N

Ball Point Hex Key Wrench Set

- 9pcs: 1.5-2-2.5-3-4-5-6-8-10mm



KA-1138N Torx Wrench Set

(with hole)

- 7pcs: T8, T10, T15, T20, T25, T27, T30



KA-0137N Hex Key Wrench Set

- 7pcs: 2-2.5-3-4-5-6-8mm



KA-0117N Hex Key Wrench Set

- 7pcs: 2.5-3-4-5-6
- ⊕2 ~ 05



KA-8350 30pcs 1/2"Dr. Hexagon Tip Bit Socket Set

- Material: 10mm bit~S2 steel, over 12mm(shank) bit CR-V steel, CR-V tip bit socket set
- 9-55mmL: 5-6-7-8-10-12-14-17-19mm
- 8-100mmL: 5-6-7-8-10-11-12-13mm
- 7-140mmL: 5-6-7-8-10-12-14mm
- 6-200mmL: 5-6-7-8-10-12mm
- All in blow mold case



KA-8351 26pcs 1/2"Dr. Spline Tip Bit Socket Set

- Material: 10mm bit S2 steel, over 12mm(shank) bit CR-V steel, CR-V tip bit socket set
- 8-55mmL: M5-6-8-9-10-12-14-16
- 7-100mmL: M5-6-8-9-10-12-14
- 7-140mmL: M5-6-8-9-10-12-14
- 4-200mmL: M8-10-12-14
- All in blow mold case



KA-8352 32pcs 1/2"Dr. Torx Tip Bit Socket Set

- Material: 10mm bit~S2 steel, over 12mm(shank) bit CR-V steel, CR-V tip bit socket set
- 10-55mmL: T-20, 25, 27, 30, 40, 45, 50, 55, 60, 70
- 10-100mmL: T-20, 25, 27, 30, 40, 45, 50, 55, 60,70
- 6-140mmL: T-40, 45, 50, 55, 60, 70
- 6-200mmL: T-40, 45, 50, 55, 60, 70
- All in blow mold case



KA-8353 32pcs 1/2"Dr. Ribe Tip Bit Socket Set

- Material: 10mm bit~S2 steel, over 12mm(shank) bit CR-V steel, CR-V tip bit socket set
- 9-55mmL: M5-6-7-8-9-10-12-13-14
- 9-100mmL: M5-6-7-8-9-10-12-13-14
- 7-140mmL: M8-9-10-10-12-13-14
- 7-200mmL: M8-9-10-12-13-14
- All in blow mold case



KA-8357 38pcs 1/2" Dr. Socket Bit Set

- 6pcs 140mmL star socket bit: T-40,45,50,55,60,70
- 1pcs star socket bit (tamper proof): T-80 x 100mmL
- 1pcs spline socket bit (tamper proof): M16 x 55mmL
- 5pcs spline socket bit:
M9x100mmL, M10x140mmL, M12x140mmL, M14x140mmL, TM16x10
- 1pcs spline socket bit: M18x78mmL
- 4pcs ribet socket bit:
R7x240mmL, R8x240mmL, R9x100mmL, R10x140mmL
- 1pcs ball point hex socket bit: H5x160mmL
- 4pcs hex socket bit: H10, H11, H13x140mmL, H7x230mmL
- 5pcs 50mmL hex socket bit: H14, H17, H19, H22, H24
- 9pcs 37mmL TS socket bit (tamper proof):
TS-10,15,20,25,27,30,40,45,50,t30x300mmL



KA-1615 13pcs Combined Socket For Alternator

Remove and install press-on type belt drive accessory pulleys.
Use an air impact tool or 1/2" ratchet or breaker bar

- Content: Complete kit for alternator, Pulleys type BOSCH
- Application: VW, Audi, Seat, Mercedes, Renault, BMW, Ford, Fiat, etc...



KA-1615A



KA-1616 18pcs Combined Socket Set For Alternator

3- Combined Socket for Alternator: 1/2"Dr. x 110mm(L): T50 & M10
3/8"Dr. x 82mm(L): M10

- 2- 15mm Hex x 33 teeth, 22mm Hex x 33 teeth
- 1- Special tool for Bosch System Alternator: Ø 34.5 x H17mm x 30L
- 3- Special tool for Renault System Alternators:
 - H22 x H22mm x 30L
 - H28 x H22mm x 30L
 - H28 x H19mm x 30L
- 1- 1/2"Dr. Bit Adaptor
- 6- 10mm x 75L bit: (6150)
 - Torx: T40-T50 & Spline: M8-M10 & Hex: H8-H10
- 1- 12mm x 64L bit (6150) : Spline: M10
- 2- 1/2"Dr. Spline Bit Socket (140mmL): M10



KA-1617

22pcs Complete kit for Bosch and DENSO Type Alternator Pulleys

3- Combined Socket for Alternator: T50 x 113mmL Socket; M10 x 113mmL Socket;
3/8"Dr. x M10 x 80mmL W/ Ø14x33T for Fiat.

- 1- Bit socket M10x140mmL.
- 3- Teeth Socket: 15mm Hex x 19mm x 33 teeth, 22mm Hex x 33 teeth,
15mm Hex x 17.5mm x 33 teeth.
- 2 - 22mm HEX Socket 17mm HEX Socket.
- 3- 22 x 28 mm Hex socket, 19 x 28 mm Hex socket, 21 x 28mm Hex socket.
- 1 - 35mm Round Socket W/4 pins.
- 1 - 38mmHex W/3Pins.
- 1 - 1/2" Dr. SQ.(F) x 10mm Hex.(F) Bits Adaptor.
- 1-M10 x H12 x 64L bit.
- 6 - 10mm(Hex Shank) x 75mmL CR-V bit: T40, T50, M8, M10, H8, H10.

Features :

- Removes and installs press-on-type belt drive accessory pulleys.
- Works with hand tools or an impact gun.
- Interchangeable components to work on VW, Audi, Seat, Mercedes Benz, Renault, BMW, Ford Renault, Fiat, etc....



KA-1323K 6pcs Alternator Freewheel Pulley Removal Set

Easy removal of free wheel pulley from alternator either on or off the vehicle. Allows alternator shaft to be held while the pulley retainer is removed.

- Applications: Audi, BMW, Citroen, Ford, Mercedes, Opel, Peugeot Renault, Vauxhall, Skoda.
- Socket Insert:
 - D: TRX T50 x 64mmL (Driver: 12mm hex)
 - C: XZN M10 x 64mmL (Driver: 12mm hex)
 - B: XZN M10 x 110mmL (Driver: 1/2" socket)
 - A: XZN M10 x 140mmL (Driver: 1/2" socket)
- Locking Insert:
 - F: 33T x Ø 19.5mm (Driver: 21mm hex)
 - E: 28mm hex (Driver: 21mm hex)

3pcs Alternator Pulley Free Wheel Wrench

KA-3988K content: KA-3988A, KA-3988B, KA-3988C

KA-3988KA content: KA-3988A, KA-3988B, KA-3988C-19





KA-1618 Common Rail Injector Tool Kit

- Special tools to loosen and remove the injectors internal fixings.
- Includes the Injector ball valve lapping tools and guide.
- Applications include Bosch, Denso and Siemens injectors.
- Contents:
 - 3 x Injector ball valve lapping tools
10mm Hex x 7.6mm
 - Denso CR Injector valve seat removal tool
 - 8 sided socket for Bosch CR Injectors
 - Internal fixing removal tool for Siemens CR injector.



KA-7260

1/4" Square Drive With Socket & Bit Drivers Set and auxiliary Shaft

- A new type of screwdriver combines with the auxiliary shaft inside the screwdriver handle.
- The auxiliary shaft let user fasten and release the screw or nut much easier.
- Chrome vanadium steel blade with chrome plated finish.
- The set is supplied with 16 hardened bits (8mm hex) & 2 sockets & 1 adaptor 1/4" sq. drive x 8mm hexagon & 1 adaptor 1/4" sq. drive x 1/4" hexagon.





	USA	EUROPE
Hex	6,, 7, 8, 10mm 1/4", 7/32", 5/16", 3/8"	6, 7, 8, 10mm
Torx	T30,T40, T45, T50	T30, T40, T45, T50
Slot	3/8", 9/32"	8mm, 10mm
Spline		8mm, 10mm
PZ		PZ3, PZ4
PH	PH3, PH4	PH3, PH4
Socket	1/2", 9/16"	13, 14mm



KA-1327K 18pcs Shock Absorber Tool Set

For repair work at the spring strut, shock absorbers, removing strut unit. For retaining the piston when installing and removing strut unit.



	Ratchet wheel, pawl, shift lever, 2 screws, ball and compression spring
	6-point: 16, 17, 18, 19, 21, 22, 24mm
	T50: 16, 17, 18, 19, 21, 22, 24mm
	For repair work at the spring strut, especially for retaining the piston road when installing or removing strut units. 7mm for MERCEDES-BENZ Vaneo 8mm for BMW 9mm for OPEL Corsa B, Astra F, G, Vectra B
	<ul style="list-style-type: none"> ⊙ 6, 7, 8mm ⊙ 5 x 8mm ⊙ 6 x 8mm For PORSCHE Cayenne S, VW-Touareg ⊙ 7.1 x 9.6mm

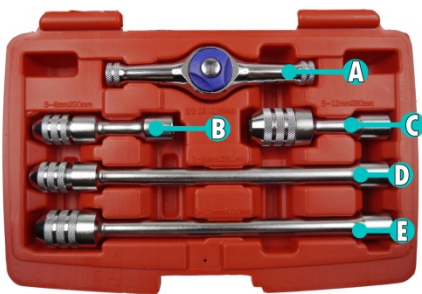

KA-6587 T-Handle Gear Tap Wrench

- Contents:
- 3/8 DR x 135mm T-Handle Ratchet x 1pc
 - 3-8mm x 90mm Tap Wrench x 1pc
 - 5-12mm x 90mm Tap Wrench x 1pc
 - 3-8mm x 230mm Tap Wrench x 1pc
 - 5-12mm x 230mm Tap Wrench x 1pc

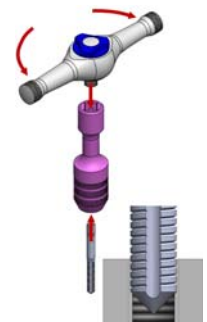

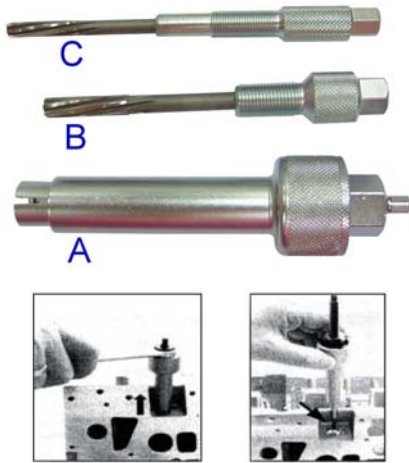

KA-1330 3pcs Pre-Heater Plug Puller Set

- To ream out and clean the bore between the glow plug and pre-combustion chamber.
- A:** For pre-heater plugs with 10mm across flats on Mercedes CDI engines (OM611, 612, 613 etc)
 - For pulling out pre-heater plugs after have been unscrewed but are still located firmly in their holes.
 - Length: 135mm
 - Drive: 19mm hex
 - B:** For Mercedes 4-Valve-engies OM604, OM605, OM606 with glow plug threads
 - Size: M12 x 1.25
 - Drive: 13mm hex
 - Glow plug: 7mm
 - C:** Important if the engine is difficult to start.
 - For Mercedes CDI engines 4.5 & 6 cylinder OM611, 612, 613 with glow plug threads M10 x 1
 - Drive: 10mm hex
 - Glow plug: 6mm

KA-1331K 6pcs Pre-Heater Plug Puller Set

- To ream out and clean the bore between the glow plug and pre-combustion chamber.
- A:** For pre-heater plugs with 10mm across flats on Mercedes CDI engines (OM611, 612, 613 etc)
 - For pulling out pre-heater plugs after have been unscrewed but are still located firmly in their holes.
 - Length: 135mm
 - Drive: 19mm hex
 - B:** For Mercedes 4-Valve-engies OM604, OM605, OM606 with glow plug threads
 - Size: M12 x 1.25
 - Drive: 13mm hex
 - Glow plug: 7mm
 - C:** Important if the engine is difficult to start.
 - For Mercedes CDI engines 4.5 & 6 cylinder OM611, 612, 613 with glow plug threads M10 x 1
 - Drive: 10mm hex
 - Glow plug: 6mm



3pcs 3/8" Dr. Glow Plug Socket

Size: 8, 9, 10 length: 83mm

Chrome vanadium steel sockets in carefully selected set of size. Hardened and tempered with chrome finish for corrosion resistance. Handles rounded fixings as well. Set supplied on socket rail and backed by lifetime warranty. These sockets have a universal joint for easy replacement and removal of popular sized glow plugs.

KA-1332K 9pcs Pre-Heater Plug Puller Set

- To ream out and clean the bore between the glow plug and pre-combustion chamber.
- A:** For pre-heater plugs with 10mm across flats on Mercedes CDI engines (OM611, 612, 613 etc)
 - For pulling out pre-heater plugs after have been unscrewed but are still located firmly in their holes.
 - Length: 135mm
 - Drive: 19mm hex
 - B:** For Mercedes 4-Valve-engies OM604, OM605, OM606 with glow plug threads
 - Size: M12 x 1.25
 - Drive: 13mm hex
 - Glow plug: 7mm
 - C:** Important if the engine is difficult to start.
 - For Mercedes CDI engines 4.5 & 6 cylinder OM611, 612, 613 with glow plug threads M10 x 1
 - Drive: 10mm hex
 - Glow plug: 6mm



6pcs 3/8" Dr. Glow Plug Socket

Size: 8, 9, 10, 12, 14, 16 length: 160mm

Chrome vanadium steel sockets in carefully selected set of size. Hardened and tempered with chrome finish for corrosion resistance. Handles rounded fixings as well. Set supplied on socket rail and backed by lifetime warranty. These sockets have a universal joint for easy replacement and removal of popular sized glow plugs.

3/8" Torque Wrench

- Adapters measure 2" from the center of the adapter opening to the center of the square drive for easy torque calculations
- High strength, thin wall design
- Applies up to 15% more torque to fastener
- Reduces risk of fastener rounding



- KA-1021-08** 3/8" x 8mm
- KA-1021-10** 3/8" x 10mm
- KA-1021-12** 3/8" x 12mm
- KA-1021-14** 3/8" x 14mm
- KA-1021-17** 3/8" x 17mm

3/8"(9.5mm) Tap Holder Socket ()

- Attach to any 3/8" Ratchet Wrench or T-bar to use.
- 用 業 作 業 用



- KA-2985** Capacity: M4 ~ M8
 - KA-2986** Capacity: M10 ~ M12
 - KA-2987** Capacity: M13 ~ M14
- Min. order: 300 pcs.



**Composite Ratchet Wrench
72 Teeth W/Quick Release**



- KA-2710** 1/4"
- KA-2711** 3/8"
- KA-2712** 1/2"

72 Teeth Ratchet Handle

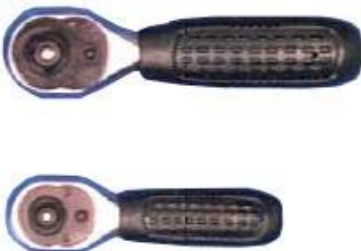

- KA-7360** 3/8"DR (5")
- KA-7361** 1/4"DR (3-3/4")



72 Teeth Flexible Locking Ratchet Handle

- KA-7362** 1/2"dr (11")
- KA-7363** 3/8"dr (8")
- KA-7364** 1/4"dr (5")



KA-3572 Pocket Tool Set

- Length: 110mm
- Torque: 250 kgf /cm
- Handle: PP + Fiber
- Ratchet Wrench 36-teeth ratchet wrench
- 12pcs bits 25L 8660 sandblast:
PH1, 2, 3, 4, 6
PZ1, 2, S1, S2, HEX3, HEX4, AD



KA-1298 3pcs Palm Ratchet Wrench Socket Adapter Set

Adapter size: 1/4" Sq-Dr. x 13mm
3/8" Sq-Dr. x 19mm
1/2" Sq-Dr. x 24mm

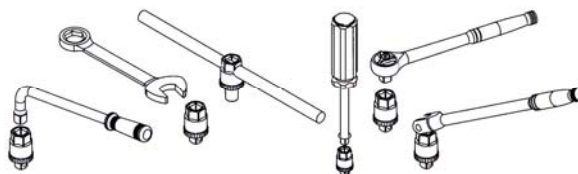

KA-1292 3pcs Spinner Buddies Set

W/O Ratcheting Mechanism

- Use your fingers to take the slack out of a bolt or nut so your ratchet can take over.
- Use as a plan drive for hand installations.
- Consists: 1/4", 3/8", 1/2"



KA-1292A 7-In-1 Ratchet Spinner

- Ideal for getting into tight places.
- Two way usages. One side is for bits, the other is for sockets.
- Built-in magnet can attract bits firmly.
- The opposite side is a 1/4" driver for sockets.
- Patented ratchet design makes the work easier.
- Delicate design-light and easy to carry.
- Bright colorful outlook is attractive to customers.
- Two-way bits increase values and efficiency.

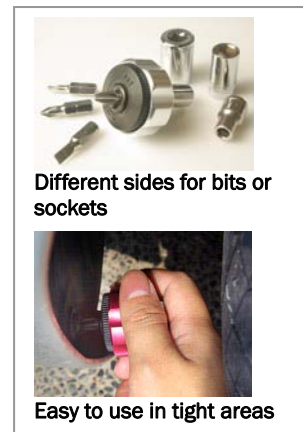

Different sides for bits or sockets

Easy to use in tight areas



KA-1196



KA-1196A

6pcs 3/8"Dr. Jointed Glow Plug Socket Set

- 3/8"Dr.
- Size: 8-9-10-12-14-16mm

KA-1196 Length: 72mm, with clip

KA-1196A Length: 83mm



KA-1197



KA-1197A

6pcs 3/8"Dr. Jointed Glow Plug Socket Set

- 6-3/8"DR. x 158mm
- size: 8-9-10-12-14-16mm

KA-1197 without clip

KA-1197A with clip



KA-1196B 5pcs 1/4" Dr. Glow Plug Socket

- 1/4" Dr.
- Size: 8-9-10-12-14mm
- Length: 70mm



KA-1198

4pcs 3/8" "T" Type Universal Joint Spark Plug Socket Set

- 1-3/8"Dr. x 200mm Sliding T Bar
- 1-3/8"Dr. x 250mm Quick Extension Bar
- 2-3/8"Dr. x universal joint spark plug socket: 5/8" & 13/16"



KA-1199

6pcs 3/8" "T" Type Universal Joint Spark Plug Socket Set

- 1-3/8"Dr. x 200mm Sliding T Bar
- 1-3/8"Dr. x 250mm Quick Extension Bar
- 4-3/8"Dr. x universal joint spark plug socket: 9/16" & 5/8" & 3/4" & 13/16"



KA-7814H Hex Nut Driver Set

Contents:

KA-7814H-2	2mm
KA-7814H-3	3mm
KA-7814H-4	4mm
KA-7814H-5	5mm
KA-7814H-6	6mm
KA-7814H-8	8mm



KA-7814-T T/4 Screwdriver

Contents:

KA-7814-T15	15mm
KA-7814-T20	20mm
KA-7814-T25	25mm
KA-7814-T30	30mm



KA-7814-HD Hex Nut Drivers

Contents:

KA-7814-HD7	7mm
KA-7814-HD8	8mm
KA-7814HD10	10mm
KA-7814HD13	13mm



KA-7814 Special Screwdriver

- 3mm x 300mm Adjust Screwdriver
- 3mm x 6 PT



T-Handle Spark Plug Wrench With Swiveling Socket

KA-6890-16M	16mm (5/8")
KA-6890-21M	21mm (13/16")



KA-5088-38T T-Handle With Foam Handle

- 3/8" 120 x 280mm
- 10MM DIA.



T-Handle Sliding Wobble

- KA-7423 1/4" 120 x 150mm
- KA-7424 3/8" 200 x 250mm
- KA-7425A 1/2" 200 x 250mm



T-Handle Socket (Hex)

- KA-4177A 8 x 9 x 10mm
- KA-4177B 8 x 10 x 12mm
- KA-4177C 10 x 11 x 13mm
- KA-4177D 10 x 12 x 14mm
- KA-4177E 12 x 14 x 17mm



3/8" Dr. Adjustable Extension Bar (CRV)

MODEL	ADJUSTABLE LENGTH	WEIGHT
KA-7329	7-10", 178-254MM	300g
KA-7330	9-15", 228-380MM	360g

1/2" DR. Adjustable Extension Bar (CRV)

MODEL	ADJUSTABLE LENGTH	WEIGHT
KA-7336	7-10", 178-254MM	430g
KA-7337	10-16", 254-400MM	600g



KA-7342B Multi Drive Angle Sliding T-Handle

- Can be use for Sliding T-Bar
- Can be Foldable
- Drive angle can be: 75° 90° 105°
- Drive: 1/2" x 3/8" x 1/4"
- Length: 230 x 250mm

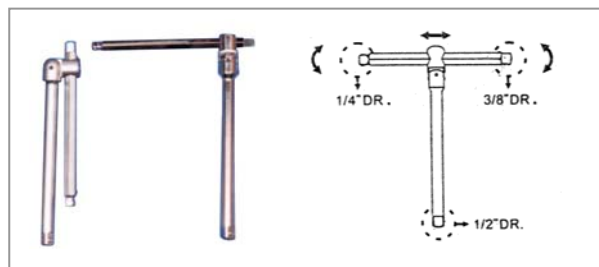



Sliding T-Handle Socket (CRV) (HEX)

■ Length: 200x300mm

MODEL	SIZE: mm
KA-7343B	8
KA-7344B	9
KA-7345B	10
KA-7346B	11
KA-7347B	12

MODEL	SIZE: mm
KA-7348B	13
KA-7349B	14
KA-7349B1	17
KA-7349B2	19



T-Handle Socket (CRV) (HEX)

■ Length: 200x300mm

MODEL	SIZE: mm
KA-7350	8
KA-7351	9
KA-7352	10
KA-7353	11
KA-7354	12

MODEL	SIZE: mm
KA-7355	13
KA-7356	14
KA-7357	17
KA-7358	19



KA-7359 3 Way T-Handle Socket (HEX)

■ Size: 8, 10, 12mm(CRV)

■ Length: 130 x 140mm

■ Content: **KA-7359A** 8 x 10 x 12mm
KA-7359B 10 x 12 x 14mm
KA-7359C 9 x 11 x 13mm



Foldable Cross Ram Wrench (CR.V)

KA-7327C 16", 1/2" DR. & 17, 19, 21mm

KA-7327D 14", 1/2" DR & 17, 19, 21mm



Sliding T-Handle With Swivel Socket

■ Length: 200 x 450mm

KA-5088A	6mm	KA-5088F	12mm
KA-5088B	8mm	KA-5088G	13mm
KA-5088C	9mm	KA-5088H	14mm
KA-5088D	10mm	KA-5088I	17mm
KA-5088E	11mm	KA-5088J	19mm



Adjustable Wobble Extension Sliding T Handle

- KA-7387W** 3/8"DR 10"~16"(250~400mm)
- KA-7388W** 1/2"DR 10"~16"(250~400mm)

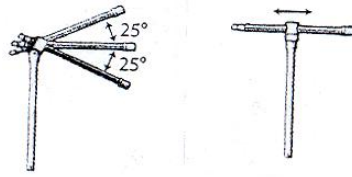

Adjustable Wobble Extension Bar

- KA-7326W** 1/4"DR 8"~12"(200~300mm)
- KA-7330W** 3/8"DR 9"~15"(225~375mm)
- KA-7337W** 1/2"DR 10"~16"(250~400mm)



5pcs Wobble Extension Bar Set

- KA-5089A** 1/4" DR x 50, 75, 100, 150, 225mm
- KA-5089B** 3/8" DR x 38, 75, 150, 250, 450mm
- KA-5089C** 1/2" DR x 50, 125, 250, 375, 500mm



5pcs Extension Bar Set

- KA-6384A** 1/4" x 50, 75, 100, 150, 225mm
- KA-6384B** 3/8" x 38, 75, 150, 250, 450mm
- KA-6384C** 1/2" x 50, 125, 250, 375, 500mm



KA-5087 1/4"DR Adjustable Wobble Extension Set

- With: 1pc 1/4"dr 7"~12"(175~300mm)
- Adjustable extension bar
- 1pc 1/4"dr mini ratchet handle 6"(150mm)



- KA-5087A**
- 1/4" Adjustable Wobble Extension Bar**
- 7"x12"

- KA-5087B**
- 1/4"DR Mini Ratchet Handle 6"**

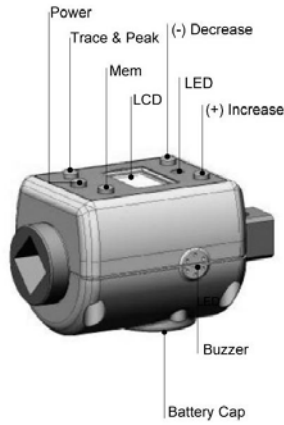

Digital Torque Adapter (5 unit set)

KA-1621, KA-1683, KA-1641, KA-1643, KA-1643N

Function:

- 50 memory record
- Track and Peak hold mode
- Auto shut off: 80 seconds (if do not use digital torque adapter)
- **5 unit set (kg-cm, kg-m, lb-in, lb-ft, N-m)**



Digital Torque Adapter (3 unit set)

KA-1621A, KA-1683A, KA-1641A

Function:

- 50 memory record
- Track and Peak hold mode
- Auto shut off: 80 seconds (if do not use digital torque adapter)
- **3 unit set (kg-m, lb-ft, N-m)**
- **LED indicator: Green, Yellow, Red**
- **Overload Alarm(125%): 250N-m, 184.4lb-ft**

Features:

Model No.	KA-1621 KA-1621A	KA-1683 KA-1683A	KA-1641 KA-1641A	KA-1643	KA-1643N
Drive	1/2"	3/8"	1/4"	3/4"	3/4"
Accuracy	±2%	±2%	±4%	±2%	±2%
Display resolution	0.1	0.1	0.1	0.1	0.1
Display Range	40~200 N-m (29.5 ~ 147.5 lb-ft)	27 ~ 135 N-m (19.9 ~ 99.6 lb-ft)	6 ~ 30 N-m (4.4 ~ 22.1 lb-ft)	100-500Nm (73.8 – 368.8lb-ft)	200 ~ 1000 N-m (147.5 ~ 737.51 lb-ft)
Weight	183g	182g	180g	570g	
Size	L75 x W45mm			L110 x W56mm	
Battery	CR2032 x 1pc			AA x 2pcs	
Battery Life (continuous operation)	55 hrs			110 hrs	
Operating Ambient Temperature	-10°C ~ 60°C (13.9°F ~ 139.9°F)				
Storage Temperature	-20°C ~ 70°C (-4°F ~ 157.9°F)				
Operating Reative Humidity	Humidity: 15 to 90% noncondensing				



17mm



19mm



21mm



Digital Torque Socket

- Put the digital torque socket on the wheel nut directly, do not need extra adaptor.
- Plus ratchet handle or any tools become a digital torque wrench.
- Combine the digital torque socket and mechanical torque wrench together make your work quick and accurate.

Specification:

- 50 memory record
- Track and Peak hold mode
- Alarm Buzzer
- 3 unit set (kg-m, lb-ft, N-m)
- Auto shut off: 80 seconds (if do not use digital torque adapter)

Feature:

Model No.	KA-1630-21	KA-1630-19	KA-1630-17
Size	1/2" Dr. x 21mm	1/2" Dr. x 19mm	1/2" Dr. x 17mm
Accuracy	±2%		
Display resolution	0.1		
Display Range	40~200 N-m (29.5 ~ 147.5 lb-ft)		
Battery	AAA x 3 pcs		
Battery Life (continuous operation)	110 hrs		
Operating Ambient Temperature	-10°C ~ 60°C (13.9°F ~ 139.9°F)		
Storage Temperature	-20°C ~ 70°C (-4°F ~ 157.9°F)		

* only used with hand operated tools



KA-1631 / KA-1632



KA-1631AD / KA-1632AD

KA-1631 / KA-1632 Digital Torque Socket Set

Specification:

- 50 memory record
- Display resolution: 0.1
- Display range: 40-200Nm
- Operation mode: Trace/Peak
- Alarm: Buzzer
- Unit: Nm, lb-ft, Kg-m
- Key: 6
- Backlight
- Battery: AAA x 3pcs
- Battery life: 110hrs
- Operation ambient temperature: -10°C ~ 60°C (13.9°F ~ 139.9°F)
- Storage temperature: -20°C ~ 70°C (-4°F ~ 157.9°F)
- Auto shut off: 80 seconds

Content:

- 1pc digital torque socket: **KA-1631** → 1/2"DR. (KA-1631AD)
KA-1632 → 3/8" Dr. (KA-1632AD)
- 3pcs wheel nut socket: 17mm x 76mmL
19mm x 76mmL
21mm x 76mmL

Feature: (KA-1631AD / KA-1632AD)

Model No.	Length	Dr.	Range	Accuracy
KA-1631AD	50mm	1/2"	40 ~ 200N-m	±2%
KA-1632AD	50mm	3/8"	27 ~ 135N-m	±2%

* only used with hand operated tools





Digital Torque Adapter With Tire Gauge

- Digital torque value reading
- Target torque value setting
- 50 memory record
- Track and Peak hold mode
- Alarm: LED light bar and buzzer
- Powered by 2 x AAA batteries
- 5 unit set (Nm, Lb-ft, In-ft,kg-m, Kg-cm)
- Auto shut off: 60 seconds (if do not use digital torque adapter)
- U.S / Taiwan Patented

	KA-1621TP	KA-1683TP
Dr	1/2"	3/8"
Accuracy	+/-2%	+/-2%
Torque Range	40-200Nm(29.5-147.6lb-ft)	27-135Nm(19.9-99.67lb-ft)
Pressure Range	1-100PSI	1-100PSI
Resolution	0.1Nm (0.1lb-ft) /0.1PSI	0.1Nm (0.1lb-ft) /0.1PSI
Preset	1	1
Pressure Unit	PSI, Kpa, Bar, Kg-cm	PSI, Kpa, Bar, Kg-cm
Length	75mm	75mm
Weight	190gs	190gs
Operating ambient temperature	-10°C-60 °C °F-139.9 °F)	-10°C-60 °C °F-139.9 °F)
Storage temperature	-20 °C -70 °C (-4 °F-57.9 °F)	-20 °C -70 °C (-4 °F-57.9 °F)
Operating relative humidity	15-90% noncondensing	15-90% noncondensing



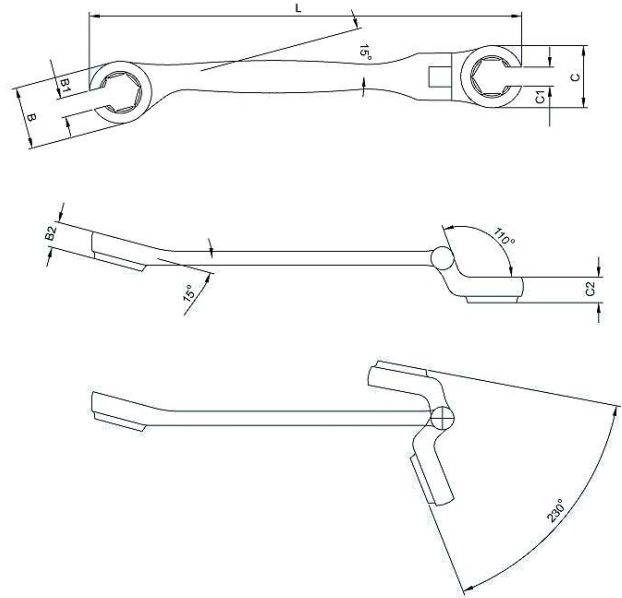

Flexible Nut Wrench

ITEM NO.: KA-2936S / KA-2936M

- MATERIAL: 6140 CRV
- FINISH:KA-2936S (SATIN), KA-2936M (MIRROR)
- HARDNESS: HRC44~48°C
- PATENTED

All Flexible Combination Wrench are to be used with 3/8" extension bar.



ADVANTAGE * Flexible End * Folds up to 100 degree * Bottom Flare Design

***Doesn't have Fold up to 100 degree * Doesn't have Bottom Flare Design**

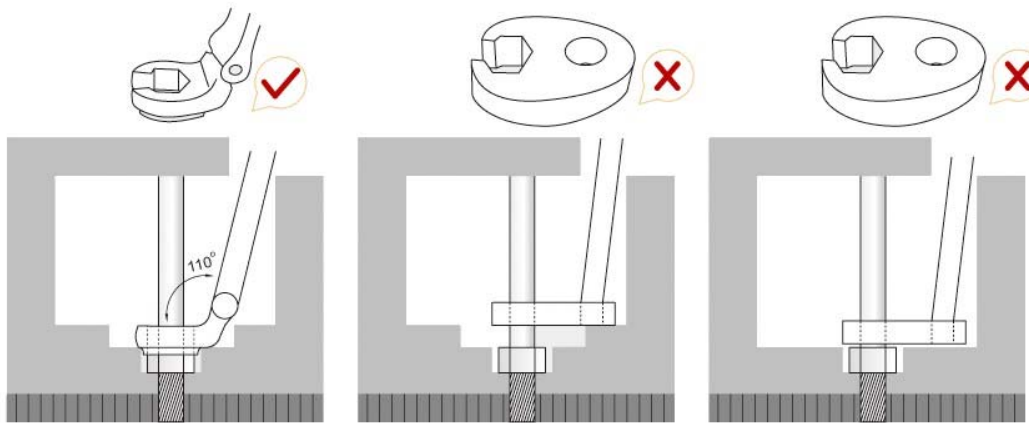

Ergonomic Design

The ergonomically stylish design allows this flare nut wrench to provide equal torque in all directions.

Users are able to continue their work without feeling any discomfort

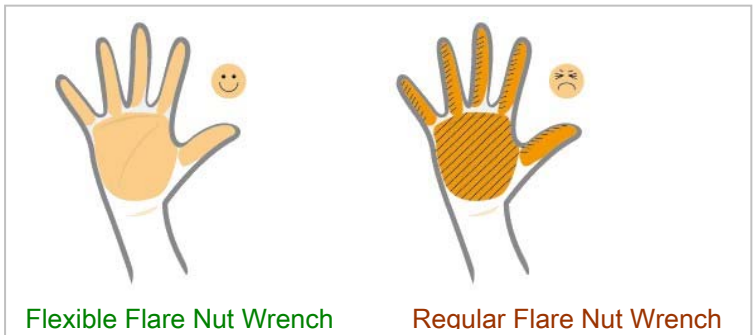

PATENTED IN U.S.A.,TAIWAN, CHINA, EUROPE.

DIFFERENCE between Flexible Head and Other Ordinary Flare Nut Wrenches

KA-2936 is design for hard-to-reach areas at up to 45 degrees. This is next to impossible for other ordinary flare nut wrenches. In areas where rotating space is not enough, users need to remove certain obstacles (such as tubing or connectors) before they can loosen or tighten a nut using ordinary flare nut wrenches. This time-consuming and tedious removal can be resolved by using our Flexible Flare Nut Wrench.



Applications for Patented Flexible Flare Nut Wrench



KA-2936S

- SATIN FINISH

KA-2936M

- MIRROR FINISH

KA-2936S/ KA-2936M METRIC SIZE (MM)

ITEM NO. & SIZE (MM)	L (mm)	BXC (mm)	B1XC1 (mm)	B2XC2 (mm)
★08BX08C 8MM	129	18x18	6x6	7x7
08BX09C 8MM	129	18x18	6x6.5	7x7
08BX10C 8MM	129	18x18	6x7	7x7
★09BX09C 9MM	129	18x18	6.5x6.5	7x7
09BX08C 9MM	129	18x18	6.56	7x7
09BX10C 9MM	129	18x18	6.5x7	7x7
★10BX10C 10MM	129	18x1	7x7	7x7
10BX08C 10MM	129	18x18	7x6	7x7
10BX09C 10MM	129	18x18	7x6.5	7x7
★11BX11C 11MM	148	22x22	8.5x8.5	9x9
11BX12C 11MM	148	22x22	8.5x9	9x9
★12BX12C 12MM	148	22x22	9x9	9x9
12BX11C 12MM	148	22x22	9x8.5	9x9
★13BX13C 13MM	175	26x26	10x10	11x1
13BX14C 13MM	175	26x26	1x11	11x11
13BX15C 13MM	175	26x26	10x12	11x11
★14BX14C 14MM	175	26x26	11x11	11x11
14BX13C 14MM	175	26x26	11x10	11x11
14BX15C 14MM	175	26x26	11x12	11x11
★15BX15C 15MM	175	26x26	12x12	11x11
15BX13C 15MM	175	26x26	12x10	11x11
15BX14C 15MM	175	2626	12x11	11x11
★17BX17C 17MM	190	31.6x31.6	14x14	12.8x12.8
17BX19C 17MM	190	31.6x31.6	14x15	12.8x12.8
★19BX19C 19MM	190	31.6x31.6	15x15	12.8x12.8
19BX17C 19MM	190	31.6x31.6	15x14	12.8x12.8
★21BX21C 21MM	235	41x41	16x1	16x16
21BX22C 21MM	235	4x41	16x17	16x16
21BX24C 21MM	235	41x41	16x18	16x16
★22BX22C 22MM	235	41x41	17x17	16x16
22BX21C 22MM	235	41x41	17x16	16x16
22BX24C 22MM	235	41x41	17x18	16x6
★24BX24C 24MM	235	41x41	18x18	16x16
24BX21C 24MM	235	41x41	18x16	16x16
24BX22C 24MM	35	41x41	18x17	16x16

KA-2936S/ KA-2936M IMPERIAL (INCH)

ITEM NO. & SIZE (INCH)	L mm	BXC (mm)	B1XC1 (mm)	B2XC2 (mm)
★5/16BX5/16C 5/16"	129	18x18	6X6	7X7
5/16BX3/8C 5/16"	129	18x18	6X7	7X7
★3/8BX3/8C 3/8"	129	18x18	7X7	7X7
3/8BX5/16C 3/8"	129	18x18	7X6	7X7
★7/16BX7/16C 7/16"	148	22x22	8.5X8.5	9X9
★1/2BX1/2C 1/2"	175	26x26	10X10	11X11
1/2BX9/16C 1/2"	175	26x26	10X11	11X11
★9/16BX9/16C 9/16"	175	26x26	11X11	11X11
9/16BX1/2C 9/16"	175	2x26	11X10	11X11
★5/8BX5/8C 5/8"	190	31.6x31.6	14X14	12.8X12.8
5/8BX11/16C 5/8"	190	31.6x31.6	14X14	12.8X12.8
5/8BX3/4C 5/8"	190	31.6x31.6	14X15	12.8X12.8
★11/16BX11/16C 11/16"	190	31.6x31.6	14X14	12.8X12.8
11/16BX5/8C 11/16"	190	31.631.6	14X14	12.8X12.8
11/16BX3/4C 11/16"	190	31.6x31.6	14X15	12.8X12.8
★3/4BX3/4C 3/4"	190	31.6x31.6	15X15	12.8X12.8
3/4BX5/8C 3/4"	190	31.6x31.6	15X14	12.8X12.8
3/4BX11/16C 3/4"	190	31.6x31.6	15X14	12.8X12.8
★7/8BX7/8C 7/8"	35	41x41	17X17	16X16
7/8BX1C 7/8"	235	41x41	17X18	16X16
★1BX1C 1"	235	41x41	18X18	16X16
1BX7/8C 1"	235	41x41	18X17	16X16

When assemble a kit, please choose ★ items.

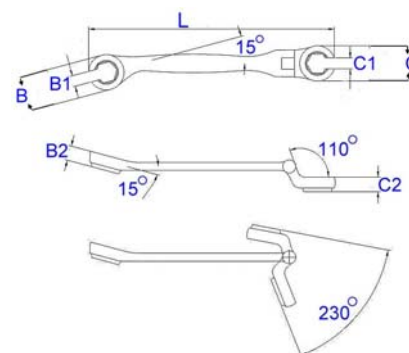



DOUBLE FLEXIBLE FLARE NUT WRENCH

KA-2939S-811 : 8 X 11 MM (SATIN FINISH)

KA-2939S-1317: 13 X 17 MM (SATIN FINISH)

KA-2939S-1419: 14 X 19 MM (SATIN FINISH)

KA-2939M-811: 8 X 11MM (MIRROR FINISH)

KA-2939M-1317: 13 X 17MM (MIRROR FINISH)

KA-2939M-1419: 14 X 19MM (MIRROR FINISH)

WORLDWIDE PATENT!!

*** More Sizes would be available soon.**

All Flexible Combination Wrench are to be used with 3/8" extension bar.



ADVANTAGE * Flexible End * Folds up to 100 degree * Bottom Flare Design

*Doesn't have Fold up to 100 degree * Doesn't have Bottom Flare Design

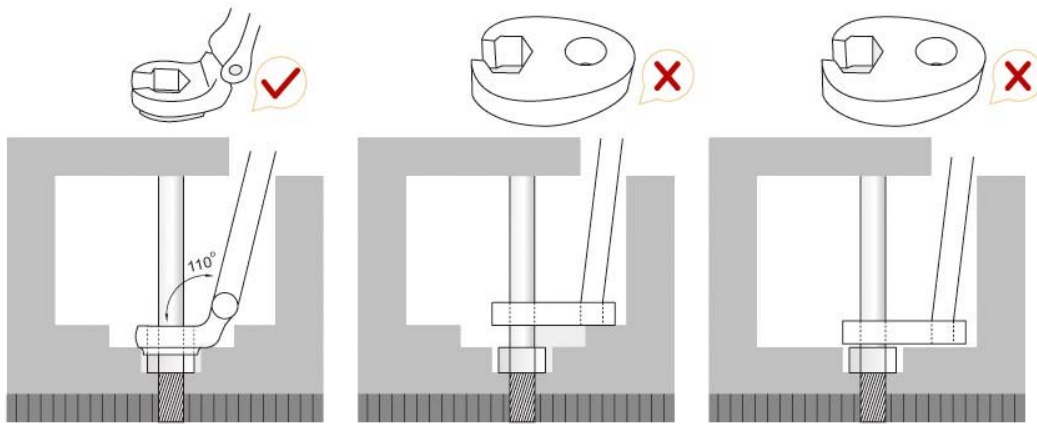

Ergonomic Design

The ergonomically stylish design allows this flare nut wrench to provide equal torque in all directions.

Users are able to continue their work without feeling any discomfort

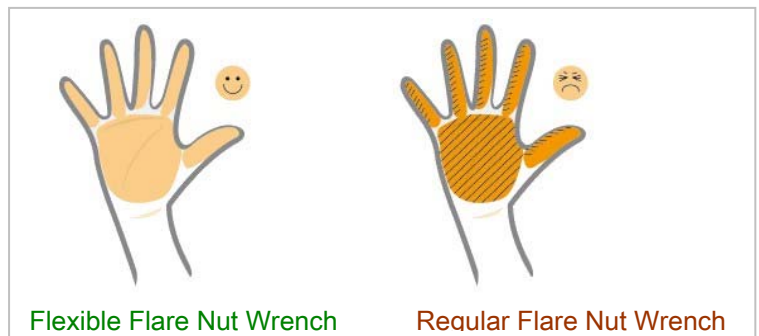



4 pcs/set Flexible Flare Nut Wrench Set

- Size: 8,10,11,12mm
- KA-2936KS** SATIN FINISH
- KA-2936KM** MIRROR FINISH



5 pcs/set Flexible Flare Nut Wrench Set

- Size: 8,9,10,11,12mm
- KA-2937KS** SATIN FINISH
- KA-2937KM** MIRROR FINISH



7 pcs/set Flexible Flare Nut Wrench Set

- Size: 8,10,11,12,13,14,17mm
- KA-2938KS** SATIN FINISH
- KA-2938KM** MIRROR FINISH



Flexible Crowfoot Wrench Set

- Package: Hanging Card or Blow Case
- MIN. Order: 500 sets

KA-2940K 10 PCS

- Size: 8,9,10,11,12,13,14,15,17,19MM

KA-2941K 8pcs

- Size: 5/16", 3/8", 7/16", 1/2", 9/16", 5/8", 11/16", 3/4"



Flexible Combination Wrench Set

- Package: Hanging Card or Blow Case
- MIN. Order: 500 sets

KA-2942K 12pcs

- Size: 8,9,10,11,12,13,14,15,16,17,18,19mm

KA-2943K 8pcs

- Size: 5/16", 3/8", 7/16", 1/2", 9/16", 5/8", 11/16", 3/4"



1/4" DR. Torque Wrench

- Length: 275mmL

KA-4386 2~24NM & 0.2~2.4MKG (EUROPEAN TYPE)
KA-4386C 20~240INCH POUNDS & 2~24NM (AMERICAN TYPE)



3/8" DR. Torque Wrench

- Length: 270mmL

KA-4258 120~960 INCH/LBS & 1.4~11.1MKG



3/8" DR. Torque Wrench

- Length: 360mmL

KA-4258BN 19~110NM & 1.9~11MKG (EUROPEAN TYPE)
KA-4258D 5~80FT/LBS & 19~110MKG (AMERICAN TYPE)



1/2" DR. Torque Wrench

- Length: 470mmL

KA-4256 28~210NM & 2.9~21.4MKG (EUROPEAN TYPE)
KA-4256A 10~150FT/LBS & 1.4~20.7MKG (AMERICAN TYPE)



1/2" DR. Torque Wrench

- Length: 470mmL

KA-4257N 28~210NM & 2.9~21.4MKG (EUROPEAN TYPE)
KA-4257AN 10~150FT/LBS & 1.4~20.7MKG (AMERICAN TYPE)



1" DR. Torque Wrench

- Length: 1120mm (44")

KA-4389 140~980NM & 14~99.9MKG (EUROPEAN TYPE)

3/4" DR. Torque Wrench



- Length: 630mmL
- KA-4387A** 50~300FT/LBS & 6.9~41.4MKG (AMERICAN TYPE)
- KA-4387B** 65~415NM & 6.6~42.3MKG (EUROPEAN TYPE)

- Length: 1075mmL
- KA-4388** 140~700NM & 14~71.4MKG (EUROPEAN TYPE)
- KA-4388A** 100~500FT/LBS & 13.8~69.1MKG (AMERICAN TYPE)
- KA-4388B** 100~600FT/LBS & 13.8~83MKG (AMERICAN TYPE)

3/4" Dr. Torque Wrench



- Stain Chrome Plated
- Length: 670mmL

- KA-4393** 60~415NM & 6.6~42.3MKG (EUROPEAN TYPE)
- KA-4393A** 50~300FT/LBS & 6.9~41.4MKG (AMERICAN TYPE)

KA-4253 1/2" DR. Micrometer Adjustable Torque Wrench



- 28~210NM & 2.9~21.4MKG (EUROPEAN TYPE)
- With: 12.7mmx125mm Extension bar
- 9.5mmx12.7mm Adapter
- Length: 500mm (20")

KA-4254 1/2" DR. Micrometer Adjustable Torque Wrench



- 10~150FT/LBS & 1.4~20.7MKG (AMERICAN TYPE)
- With: 1/2"x5" Extension bar
- 3/8"x1/2" Adapter
- Length: 500mm (20")

KA-4394 5pcs Changeable Spanner Torque Wrench



- Torque: 10~18~42-55~65~75NM (EUROPEAN TYPE)
- SPANNER SIZE: 17-22-24-27mm

KA-4395 7pc Changeable Spanner Torque Wrench



- Torque: 10~18~42-55~65~75NM (EUROPEAN TYPE)
- SPANNER SIZE: 17-22-24-26-27-29mm



KA-6637 Motor Angular Torque Gauge

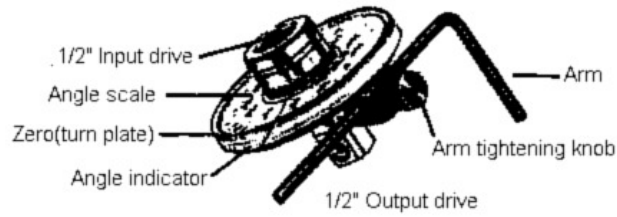

1/2" Dr. Torque Wrench

- Length: 480mm

KA-5113 0~200NM & 0~21MKG (EUROPEAN TYPE)

KA-5112 0~150FT/LBS (AMERICAN TYPE)



3/8" DR. Window Click Type Torque Wrench

- Length: 395mm

KA-4390 14~119NM (EUROPEAN TYPE)

KA-4390A 10~100FT/LBS (AMERICAN TYPE)



1/2" DR. Window Click Type Torque Wrench

- Length: 515mm

KA-4391 42~210NM (EUROPEAN TYPE)

KA-4391A 30~150FT/LBS (AMERICAN TYPE)



3/8" DR. Window Click Type Torque Wrench Kit

KA-4390K 14~119NM (EUROPEAN TYPE)

With: Sockets: 14-17-19-21-23mm
Extension: 12.7x125mm

KA-4390KA 10~100FT/LBS (AMERICAN TYPE)

With: Sockets: 14-17-19-21-23mm
Extension: 1/2"x5"



1/2" DR. Window Click Type Torque Wrench Kit

KA-4392 42~210NM

With: Sockets: 14-17-19-21-23mm
Extension: 12.7x125mm

KA-4392A 30~150FT/LBS

With: Sockets: 14-17-19-21-23mm
Extension: 1/2"x5"



KA-8011 Torque Angle Meter (Clip)

- Use with 1/2" Dr. commonly used for tightening head bolts and other bolts where a torque angle is required.

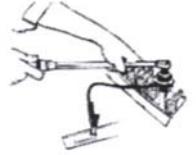

KA-8012 Torque Angle Meter (Magnetic)

- Use with 1/2" Dr. commonly used for tightening head bolts and other bolts where a torque angle is required.



KA-6637A Torque Angular Gauge

- 1/2"



Quick Release



Reversible

Part No.	Size	L(mm)			
KA-2310	1/4" Dr.	110	26	22	100
KA-2311	3/8" Dr.	135	32	30	226
KA-2312	1/2" Dr.	170	40	38	442



KA-4236 17pcs Go-Through L-Socket Set

- Extension Bar: 1PC 1/4" x 4", 1PC 3/8" x 6", 1PC 1/2" x 10"
- Socket(10PC): 8-9-10-11-12-13-14-17-19-21
- Adapter(3PC): 1/4" x 1/4", 3/8" x 3/8", 1/2" x 1/2"



KA-4237 8pcs Go-Through L-Socket Set

- Extension Bar: 1PC 1/4" x 4"
- 1PC 3/8" x 6"
- 1PC 1/2" x 10"
- Socket: 8-10-13-13-17mm



KA-4238 1/2" DR. 4pcs Go-Through L-Socket Set

- Extension Bar: 1PC 1/2" x 10"
- Socket: 10-19-21mm



KA-4239 3/8" DR. 5pcs Go-Through L-Socket Set

- Extension Bar: 1PC 3/8" x 6"
- Socket: 11-12-13-14mm



KA-4240 1/4" DR. 4pcs Go-Through L-Socket Set

- Extension Bar: 1PC 1/4" x 4"
- Socket: 8-9-10mm



KA-T10020 3/8" Mini T-Bar Ratchet Wrench

- Feature: T-handle allows for free use in confined space.
- Material: CRV
- Finish: Highly Polished Chrome-Plating
- Weight: 274g



KA-T10021 1/4" Mini T-Bar Ratchet Wrench

- Feature: T-handle allows for free use in confined space.
- Material: CRV
- Finish: Highly Polished Chrome-Plating
- Weight: 150g



KA-T10022 3/8" T-Bar Ratchet Wrench

- Feature: T-handle allows for free use in confined space.
- Material: CRV
- Finish: Highly Polished Chrome-Plating
- Weight: 350g



KA-T10023 1/2" T-Bar Ratchet Wrench

- Feature: T-handle allows for free use in confined space.
- Material: CRV
- Finish: Highly Polished Chrome-Plating
- Weight: 380g



KA-T10024 3/8" T-Bar Ratchet Wrench

- Feature: T-handle allows for free use in confined space.
- Material: CRV
- Finish: Highly Polished Chrome-Plating
- Weight: 330g



Extension T-Bar Ratchet Wrench

KA-T10028 1/2"
KA-T10029 3/8"

- Both ends of the T-handle can be extended.
- Ergonomic, Labor-saving
- Material: CRV
- Finish: Highly Polished Chrome Plating
- KA-T10028 : 700g, KA-T10029: 680g





KA-T10026K 1/2" T-Bar Ratchet Socket Wrench

- Two socket: 17x19mm, 21x23mm
- Great for confined spaces.
- Material: CRV
- Finish: Highly Polished Chrome Plating
- Weight: 1.35g



KA-T10027K 1/2" Four Step Extension Handle

- Great for confined spaces.
- Material: S45C
- Finish: Chrome Plating
- Weight: 880g
- Two socket: 17x19mm, 21x23mm for almost all lug nut.
- Extendable Neck



KA-T10030K 1/2" Separable Cross Wrench

- Unique design, Patent in U.S.A. & Taiwan.
- Two Application:
 - Use alone with the socket
 - Assemble with the 12" long lever to use as a cross wrench. The transverse lever rotate quickly.
- Torque: 60kg
- Dual Head socket: 17 x19mm, 21 x 23mm
- Ergonomic, Labor-saving
- Material: Medium Carbon 45C
- Finish: Matte Golden, Chrome-Plated



Heavy Duty Breaker Bar

- Strong head design for professional use chrome molybdenum steel

KA-4222A 1/2" DR. x 18"

KA-4222B 1/2" DR. x 24"

KA-4222C 1/2" DR. x 30"



Flexible High Torque Ratchet Handle

KA-4221A

- 512Nm (5217 kgf-cm)
- S1/2" x 18"





Opening Single Ended Ratchet Wrench

Can be used on pneumatic & hydraulic connections such as brake pipes.
hand with coating cover

KA-3480A	10mm	KA-3480G	19mm
KA-3480B	11mm	KA-3480H	22mm
KA-3480C	12mm	KA-3480I	24mm
KA-3480D	13mm	KA-3480J	27mm
KA-3480E	14mm	KA-3480K	32mm
KA-3480F	17mm		

KA-3480K6 6pc/set 10-11-13-17-19-22mm



Opening Single Ended Ratchet Wrench

Can be used on pneumatic & hydraulic connections such as brake pipes.
hand satin finish

KA-3481A	10mm	KA-3481G	19mm
KA-3481B	11mm	KA-3481H	22mm
KA-3481C	12mm	KA-3481I	24mm
KA-3481D	13mm	KA-3481J	27mm
KA-3481E	14mm	KA-3481K	32mm
KA-3481F	17mm		

KA-3481K6 6pc/set 10-11-13-17-19-22mm

KA-3481K6C 6pc/set 10-11-14-17-19-22mm



Quick Grip Wrench

KA-3482 8", 8~17mm

KA-3483 12", 14~32mm



KA-3484 1/2" Impact-Driver

- 1 - 1/2" impact driver
- 1 - 1/2" x 5/16 socket
- 36L Bit - PH2, PH3
- 36L Bit slotted - 8, 10
- 80L Bit - PH2
- 80L Bit slotted - 8



KA-3485 3/8" Impact-Driver

- 1pc - 3/8" impact driver
- 1pc - 3/8" x 5/16 socket
- 1pc - 3/8" x 1/4 socket
- 2pcs - 1/4" x 22L Bit - 4, 6
- 3pcs - 1/4" x 25L Bit - PH1, PH2, PH3
- 3pcs - 5/16" x 32L Bit - PH1, PH2, PH3
- 2pcs - 5/16" x 32L Bit - 10-12, 14-16



KA-3486 8pcs Impact-Driver

- 1 - 1/2" impact driver
- 1 - Impact bit 1/2"Dr. x 5/16"
- Bit PH2, PH3 (36mmL)
- Bit slotted - 8, 10 (36mmL)
- Bit PH2 (80mmL)
- Bit slotted - 8 (80mmL)



KA-1200 3pcs 1/2"DR. Shaft Impact Deep Socket Set

- 3pcs - 1/2"DR. shaft impact deep socket (12PT): 30-32-36mm
- (CR-Mo steel ,Hardened & Phosphate Finish)



KA-1200A 5pcs 1/2"DR. Shaft Impact Deep Socket Set

- 3pcs - 1/2"DR. shaft impact deep socket (12PT): 30-32-34-35-36mm
- (CR-Mo steel ,Hardened & Phosphate Finish)



KA-4262K 3pcs 1/2"D R. Shaft Impact Deep Socket Set

- 3pcs - 1/2"DR. wheel nut impact deep socket: 17-19-21mm
- CR-Mo steel ,Hardened & Color Finish , (Bule,Yellow,Red)
- White Plastic Holder



KA-4263A 5pcs 1/2"Dr. Wheel Nut Impact Deep Socket Set

- 5pcs - 1/2"DR. wheel nut impact deep socket: 15-17-19-21-22mm
- CR-Mo steel ,Hardened & Color Finish , (Green,Bule,Yellow,Red,Purple)
- White Plastic Holder



KA-4263B 5pcs 1/2"D r. Wheel Nut Impact Deep Socket Set

- 5pcs - 1/2"DR. wheel nut impact deep socket: 17-19-21-22-24mm
- CR-Mo steel ,Hardened & Color Finish , (Bule,Yellow,Red,Purple,Jasper)
- White Plastic Holder

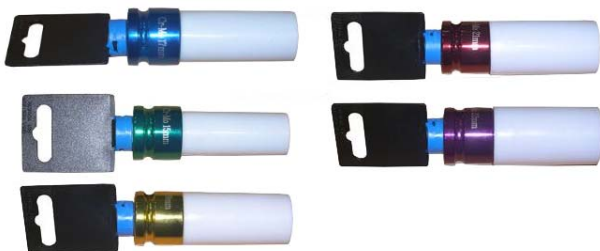

1/2"D r. Wheel Nut Impact Deep Socket Set

- CR-Mo steel ,Hardened
- White Plastic Holder
- w / Plastic Hanger

- KA-4263-1** 1/2"DR. x 15mm
- KA-4263-2** 1/2"DR. x 17mm
- KA-4263-3** 1/2"DR. x 19mm
- KA-4263-4** 1/2"DR. x 21mm
- KA-4263-5** 1/2"DR. x 22mm



KA-1215 8pcs 1/2"Dr. Impact Torx Bit Socket Set

8pcs - impact Torx bit socket: T30-T40-T45-T50-T55-T60-T70-T80
(CR-Mo steel ,Hardened & Black Phosphate Finish)



KA-1216 8pcs 1/2"Dr. Impact Hex Bit Socket Set

8pcs - impact Hex bit socket: 5-6-8-10-12-14-17-19mm
(CR-Mo steel ,Hardened & Black Phosphate Finish)



KA-1217 8pcs 1/2"Dr. Impact Spline Bit Socket Set

8pcs - impact Spline bit socket: 5-M6-M8-M10-M12-M14-M16-M18
(CR-Mo steel ,Hardened & Black Phosphate Finish)



KA-1218 8pcs 1/2"Dr. Impact Ribe Bit Socket Set

8pcs - impact Ribe bit socket: RM5-RM6-RM7-RM8-RM10-RM11-RM12-RM13
(CR-Mo steel ,Hardened & Black Phosphate Finish)



KA-1219 19pcs 1/2"Dr. Spline Socket Set

19pcs - Spline socket: 8-9-10-11-12-13-14-15-16-17-18-19-20-21-22-24-27-30-32
(CR-V steel ,Hardened & Sandblasted Mat plated)



KA-1220 12pcs 1/4"Dr. Spline Socket Set

19pcs - Spline socket: 4-5-5.5-6-7-8-9-10-11-12-13-14
(CR-V steel ,Hardened & Sandblasted Mat plated)



KA-1221 6pcs 1/4"Dr. Deep "E" Type Socket Set

6pcs - Deep "E" type socket: E4-E5-E6-E7-E8-E10
 CR-V steel ,Hardened & Sandblasted Mat plated
 Steel Rack 115mm(L)
 Slide card



KA-1222 6pcs 3/8"Dr. Deep "E" Type Socket Set

11pcs - Deep "E" type socket: E4-E5-E6-E7-E8-E10-E11-E12-E14-E16-E18
 (CR-V steel ,Hardened & Sandblasted Mat plated)



KA-1223 10pcs 1/2"Dr. Deep "E" Type Socket Set

10pcs - Deep "E" type socket: E8-E10-E11-E12-E14-E16-E18-E20-E22-E24
 (CR-V steel ,Hardened & Sandblasted Mat plated)



KA-8354 Interchangeable Wrench Socket Set

11pcs- 1/4" Dr. Socket: 4-4.5-5-5.5-6-7-8-9-10-11-12mm
 7pcs- 3/8" Dr. Socket: 13-14-15-16-17-18-19mm
 2pc- 1/2" Dr. Interchangeable Deep Socket: 14mm, 19mm
 1pc- 1/4" Dr. Interchangeable Quick-Release Adapter
 1pc- 3/8" Dr. Interchangeable Quick-Release Adapter
 20pcs- 1/4" Dr. Bit:
 H3, H4, H5, H6, PH1, PH2, PH3, PZ1, PZ2, PZ3., FD4, FD5.5, FD7, T8, T10, T15, T20, T25, T27, T30
 1pc- 1/4" Dr. Interchangeable Bit Holder
 9pcs- Interchangeable Socket: 15-16-17
 1pc- Interchangeable Wrench



For Bit



For Deep Bit Socket



For Socket



For Deep Socket



KA-3358K Torque Screw Driver with 28 Bits/Adapters

PATENT: TAIWAN, GERMANY, CHINA, U.S.A

Screwdriver with 28 bits contents:

5PCS - Hex bits L25mm: 3, 4, 5, 6, 8mm
 5PCS - Slotted bits L25mm: 3, 4, 5.5, 6.5, 7mm
 4PCS - Phillips bits L25mm: NO. 0, 1, 2, 3
 4PCS - Tri Wing bits L25mm: NO.1, 2, 3, 4
 2PCS - Posidrive bits L25mm: No. 1, 2
 6PCS - Torx bits L25mm: T10, T15, T20, T25, T30, T40
 1PCS - Bit holder L60mm
 1PCS - 1/4" Dr. Socket adapter L25mm
 Material : bits steel # S2

Screwdriver:

1PCS - Torque Screw Drivers 1 to 4 NM > ±6% <
 # Torque Screw Driver Body material is compiled with PAHs and pass SGS test.





KA-7311K-10MH
10pcs 3/8"Dr. Metric Flare Nut Crowfoot Wrench Set
 ■ 10PC-MM Size: 10, 11, 12, 13, 14, 15, 16, 17, 18, 19mm



KA-7311K-11SH
11pcs S.A.E Flare Nut Crowfoot Wrench Set
 S.A.E Size: 3/8" DR. 3/8", 7/16", 1/2", 9/16", 5/8", 11/16", 3/4", 1/2" DR. 13/16", 7/8", 15/16", 1"



KA-7311K-11M
11pcs Professional Metric Crowfoot Wrench Set
 Metric Size: 1/2" DR. 20, 21, 22, 23, 24, 25, 26, 27, 28, 30, 32mm



KA-7311K-13M
13pcs Professional Metric Crowfoot Wrench Set
 Metric Size: 1/2" DR. 20, 21, 22, 23, 24, 25, 26, 27, 28, 30, 32mm



KA-7311K-12S
12pcs Professional S.A.E. Crowfoot Wrench Set
 S.A.E. Size :
 3/8" DR. 5/16", 3/8", 7/16", 1/2", 9/16", 5/8", 11/16", 3/4"
 1/2" DR. 13/16", 7/8", 15/16", 1"



KA-7311K-15M
15pcs Professional Metric Crowfoot Wrench Set
 Metric Size:
 3/8" DR. 8, 9, 10, 11, 12, 13, 14, 15, 16, 17, 18, 19mm
 1/2" DR. 21, 22, 24mm



KA-7311K-16S
16pcs Professional S.A.E. Crowfoot Wrench Set
 S.A.E. Size:
 3/8" DR. 5/16", 3/8", 7/16", 1/2", 9/16", 5/8", 11/16", 3/4"
 1/2" DR. 13/16", 7/8", 15/16", 1", 1-1/16", 1-1/8", 1-3/16", 1-1/4"



19pcs Professional Metric Crowfoot Wrench Set
KA-7311K-19M (Silver Finish)
KA-7311K-19MB (Black Finish)
 Metric Size:
 3/8" DR. 8, 9, 10, 11, 12, 13, 14, 15, 16, 17, 18, 19mm
 1/2" DR. 21, 22, 24, 27, 28, 30, 32mm



KA-3987 98pcs Bit Set

- 21-PHILLIPS: #1X7, #2X7, #3X7
- 21-POZI: #1X7, #2X7, #3X7
- 14-SLOTTED: 4X7, 6X7
- 21-HEX: 4X7, 5X7, 6X7
- 14-TX: T10X2, T15X2, T20X2, T25X2, T27X2, T30X2, T40X2
- 7-TAMPER TX: T10, 15, 20, 25, 27, 30, 40
- 1- 60mm stainless magnetic bit holder
- 1- 60mm quick magnetic bit holder



16pcs Pin Punch Set

KA-2304K MM size

- 1-Chisel Gauge
- 3-Flat Chisel: 9.5 x 140mm, 12.7 x 150mm, 16 x 165mm
- 2-Center Punch: 3 x 130mm, 5 x 150mm
- 5-Pin Punch: 2 x 110mm, 3 x 120mm, 4 x 130mm, 5 x 135mm, 6 x 145mm
- 5-Starter Punch: 2.5 x 130mm, 3 x 145mm, 4 x 150mm, 5 x 160mm, 6 x 170mm

KA-2305K Inch Size

- 1-Chisel Gauge
- 3-Flat Chisel: 3/8" x 140mm, 1/2" x 150mm, 5/8" x 165mm
- 2-Center Punch: 1/8" x 130mm, 13/64" x 150mm
- 5-Pin Punch: 3/32" x 110mm, 1/8" x 120mm, 5/32" x 130mm, 3/16" x 135mm, 1/4" x 145mm
- 5-Starter Punch: 3/32" x 130mm, 1/8" x 145mm, 5/32" x 150mm, 3/16" x 160mm, 1/4" x 170mm



KA-2305K-12 12PCS Punch & Chisel Set

Content:

- 11mm x 3/8" x 170mm Chisel
- 13mm x 7/16" x 180mm Chisel
- 16mm x 1/2" x 205mm Chisel
- 19mm x 5/8" x 205mm Chisel
- 22mm x 3/4" x 255mm Chisel
- 25mm x 7/8" x 255mm Chisel
- 5mm x 7/16" x 205mm Center Punch
- 4mm x 3/8" x 155mm Center Punch
- 9mm x 1/2" x 205mm Pin Punch
- 9mm x 1/2" x 255mm Taper Punch
- 5mm x 7/16" x 255mm Taper Punch
- 3mm x 3/8" x 155mm Taper Punch
- Material: CRV-6150
- Package: Pouch Bag



KA-2306K 8pcs Pin Punch Set

- Millimeter size
- 8-Pin Punch:
 - 1.5 x 130mm, 2 x 130mm, 3 x 135mm, 4 x 140mm
 - 5 x 145mm, 5.5 x 150mm, 6 x 155mm, 8 x 160mm



KA-2308K 8pcs Pin Punch Set

- Millimeter size
- 8-Pin Punch
 - 1.5 x 130mm, 2 x 130mm, 3 x 135mm, 4 x 140mm
 - 5 x 145mm, 5.5 x 150mm, 6 x 155mm, 8 x 160mm



Adjustable Torque Screwdriver with Twin Display

- Two windows display for in-lb and N.m.
- Accuracy: ± 6%
- Soft grip handle manufactured from TPR for comfortable use
- Quick change design w/mini effort
- Application: air bag, crash sensor, inertia reel fixtures
- PAT. & SGS



Item No.	In-lb range	N.m. range
KA-1241	5in-lb to 35 in-lb	0.5 N.m. to 4 N.m.
KA-1242	20 in-lb to 90 in-lb	2 N.m. to 10 N.m.

KA-1243 6 N-m Limited Torque Screwdriver

- Removable T-handle for 3/8" tetragonal wrenches
- Torque value: 6 N.m.
- 1/4" hex joint for bits
- Application: Carbon bike screw. CNC cutting tool replacement, Air bag, Crash sensor, Aerospace industry...
- Not suitable for use with impact type wrenches
- Can't be calibrated



KA-3633 Special Wrench for Turbo

The Special Wrench For Turbo
Special wrench for screwing on the turbo-charger in diesel engines of VW / AUDI; new model, short type, from now on very convenient assembling and disassembling for screw underneath the turbo-charger.

- For:VW / AUDI
- Drive: 3/8" □
- Size : 12 mm x 12PT



KA-8076K 3pcs Open-End Wrench Set

- Open-end 12PT socket for the operation of screwed connections on injection lines.
- Application: for MAN
- commercial vehicles with D20 engines Common Rail injection systems.
- 1/2" DR. 14, 17, 19mm
- 12PT x 6PT x 78mmL



Open Ended Ring Wrench Socket Set

Specially designed to loosen and tighten nuts and bolts in confined spaces – e.g. Fuel Injector Connections.



Item No.	Content / Size	Descr ption
KA-3634K	KA-3634-12 12	Drive: 1/2" □ Length: 80 mm HEX (6PT)
	KA-3634-14 14	
	KA-3634-16 16	
	KA-3634-17 17	
	KA-3634-18 18	
KA-3635K	KA-3634-19 19	Drive: 1/2" □ Length: 100 mm HEX (12PT)
	KA-3635-12 12	
	KA-3635-14 14	
	KA-3635-16 16	
	KA-3635-17 17	
	KA-3635-18 18	
	KA-3635-19 19	



KA-2998 7pcs Screwdriver Set

- Chrome vanadium steel blades
- Thermoplastic soft grip handles
- Precision Ground magnetic tips
- Satin chrome plated
- Contents:

- 4 Slotted
3 x 75mm
5 x 100mm
6 x 100mm
8 x 150mm

- ⊕ 3 PHIP
PH NO.0 x 75mm
PH NO.1 x 75mm
PH NO.2 x 100mm



KA-2999 8pcs Screwdriver Set

- Chrome vanadium steel blades
- Thermoplastic soft grip handles
- Precision Ground magnetic tips
- Satin chrome plated
- Contents:

- 4 Slotted
8 x 150mm
7 x 75mm (6 x 100mm)
3 x 75mm
6 x 38mm

- ⊕ 4 PHIP
PH NO.0 x 75mm
PH NO.1 x 75mm
PH NO.2 x 100mm
PH NO.2 x 38mm



KA-3000 9pcs Gear Type Socket Driver Set

- Chrome vanadium steel blades
- Thermoplastic soft grip handles
- Precision Ground magnetic tips
- Satin chrome plated
- Size: 5-5.5-6-7-8-9-10-11-12mm
- L: 180mm

Preset Torque Screwdriver

- Two-value display for in-lb and N.m.
- Soft grip handle manufactured from TPR for comfortable use.
- Persistent fastening for quality control.
- Accuracy: ±6%
- Audible click at achieved torque w/automatic rest.



Application: air valve of wheel

Item no.	Torque preset	Torque N.m.
KA-1244	5 in-lbs	0.56 N.m.
KA-1245	7.5 in-lbs	0.85 N.m.
KA-1246	10 in-lbs	1.1 N.m.
KA-1247	12.5 in-lbs	1.4 N.m.
KA-1248	15 in-lbs	1.7 N.m.
KA-1249	20 in-lbs	2.2 N.m.
KA-1250	25 in-lbs	2.8 N.m.



An assembly 1/4" tetragonal adapter for 1/4" standard Hex. bits

Item no.	Torque preset	Torque N.m.
KA-1251	30 in-lbs	3.4 N.m.
KA-1252	35 in-lbs	3.9 N.m.
KA-1253	40 in-lbs	4.5 N.m.
KA-1254	50 in-lbs	5.6 N.m.
KA-1255	60 in-lbs	6.8 N.m.
KA-1256	70 in-lbs	7.9 N.m.

Double Open End Wrench –Platinum Wrench



- DROP FORGED
- CHROME VANADIUM SEEL
- A. MIRROR POLISHED
- B. SATIN PLATED

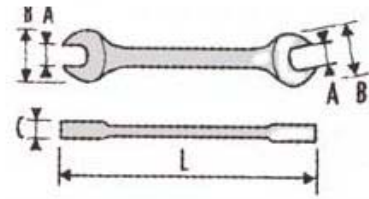

METRIC SIZE

ART NO.	SIZE(mm)	B x B1 (mm)	C x C1 (mm)	L (mm)	ART NO.	SIZE(mm)	B x B1 (mm)	C x C1 (mm)	L (mm)
KT-05-203	6x7	15.5x18.0	3.7	123	KT-05-227	19x22	15.5x18.0	3.7	237
KT-05-204	6x8	15.5x18.0	3.7	123	KT-05-228	20x22	20.4x22.7	4	237
KT-05-206	8x9	20.4x22.7	4	140	KT-05-231	21x23	20.4x22.7	4	247
KT-05-207	8x10	20.4x22.7	4	140	KT-05-234	22x24	24.9x27.1	5	247
KT-05-208	10x11	24.9x27.1	5	156	KT-05-235	23x26	24.9x27.1	5	263
KT-05-209	10x12	24.9x27.1	5	156	KT-05-238	24x27	29.2x31.2	5.5	263
KT-05-211	11x13	29.2x31.2	5.5	172	KT-05-241	25x28	29.2x31.2	5.5	279
KT-05-212	12x13	29.2x31.2	5.5	172	KT-05-245	27x30	31.3x33.3	5.5	286
KT-05-213	12x14	31.3x33.3	5.5	180	KT-05-246	27x32	33.3x35.3	5.9	286
KT-05-218	14x15	33.3x35.3	5.9	190	KT-05-248	30x32	33.3x38.9	6.1	298
KT-05-219	14x17	33.3x38.9	6.1	195	KT-05-252	36x41	37.1x38.9	6.3	375
KT-05-221	16x17	37.1x38.9	6.3	204	KT-05-255	38x42	40.9x42.8	6.7	375
KT-05-223	17x19	40.9x42.8	6.7	221	KT-05-260	46x50	94.5x103.0	16.8	460
KT-05-224	18x19	15.5x18.0	3.7	221					

POUCH BAG SET

ART NO.	SET	SIZE (mm)
KT-0506K	6PCS	8x9, 10x11, 12x13, 14x15, 16x17, 18x19
KT-0508K	8PCS	6x7, 8x9, 10x11, 12x13, 14x15, 16x17, 18x19, 20x22
KT-0511K	11PCS	6x7, 8x9, 10x11, 12x13, 14x15, 16x17, 18x19, 20x22, 21x23, 22x24, 24x27
KT-0512K	12PCS	6x7, 8x9, 10x11, 12x13, 14x15, 16x17, 18x19, 20x22, 21x23, 24x27, 25x28, 30x32mm

Stubby Type Combination Wrench



ITME NO.	SIZE (mm)	A (mm)	B (mm)	C (mm)	D (mm)	L (mm)
KT-02-206	6	13.1	10.0	4.6	5.8	77
KT-02-207	7	15.8	13.3	5.0	5.8	80
KT-02-208	8	17.8	13.5	5.2	5.9	85
KT-02-209	9	18.9	14.2	5.2	6.0	90
KT-02-210	10	22.2	13.1	5.8	7.5	95
KT-02-211	11	23.9	17.9	6.1	7.8	100
KT-02-212	12	25.5	19.1	6.6	7.8	104
KT-02-213	13	27.1	19.9	7.0	9.1	109
KT-02-214	14	29.2	21.8	7.6	9.4	114
KT-02-215	15	30.1	22.5	7.8	9.6	120
KT-02-216	16	32.8	24.1	7.9	9.8	124
KT-02-217	17	35.8	26.1	8.7	10.8	130
KT-02-218	18	36.7	27.0	9.1	11.0	134
KT-02-219	19	38.1	28.6	9.9	11.9	140
KT-02-222	22	39.7	29.8	10.3	12.5	165

Combination Wrench



- DROP FORGED
- CHROME VANADIUM SEEL
- A. MIRROR POLISHED
- B. SATIN PLATED

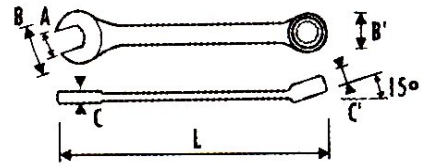

POUCH BAG SET

ART NO.	SET	SIZE (mm)
KT-0106K	6PCS/PH	10, 12, 13, 14, 15, 17mm
KT-0116K	6PCS/PH	8, 9, 10, 14, 17, 19mm
KT-0111K	11PCS/PH	7, 8, 9, 10, 11, 12, 13, 14, 15, 17, 19mm
KT-0121K	11PCS/PH	8, 9, 10, 11, 12, 13, 14, 17, 19, 21, 24mm
KT-0112K	12PCS/PH	8, 9, 10, 11, 12, 13, 14, 15, 16, 17, 19, 22mm
KT-0114K	14PCS/PH	10, 11, 12, 13, 14, 17, 19, 21, 22, 23, 24, 26, 30, 32mm
KT-0124K	14PCS/PH	8, 9, 10, 11, 12, 13, 14, 15, 16, 17, 19, 21, 22, 24mm
KT-0117K	17PCS/PH	8, 9, 10, 11, 12, 13, 14, 15, 16, 17, 18, 19, 20, 21, 22, 23, 24mm
KT-0125K	17PCS/PH	6, 7, 8, 9, 10, 11, 12, 13, 14, 15, 16, 17, 18, 19, 20, 21, 22mm
KT-0126K	26PCS/PH	6, 7, 8, 9, 10, 11, 12, 13, 14, 15, 16, 17, 18, 19, 20, 21, 22, 23, 24, 25, 26, 27, 28, 29, 30, 32mm

METRIC SIZE

ART NO.	SIZE(mm)	B x B1 (mm)	C x C1 (mm)	L (mm)	ART NO.	SIZE(mm)	B x B1 (mm)	C x C1 (mm)	L (mm)
KT-01-206	6	15.5x10.1	4.0x4.7	105	KT-01-225	25	52.0x36.9	8.9x12.5	295
KT-01-207	7	17.0x11.5	4.0x5.0	115	KT-01-226	26	53.6x38.2	9.2x12.8	305
KT-01-208	8	19.2x12.8	4.5x5.5	125	KT-01-227	27	55.7x39.6	9.4x13.1	315
KT-01-209	9	21.2x14.2	4.5x5.9	135	KT-01-228	28	57.6x40.9	9.7x13.3	325
KT-01-210	10	23.2x15.6	5.0x6.5	145	KT-01-229	29	59.7x42.3	9.9x13.5	335
KT-01-211	11	25.3x16.9	5.4x6.9	155	KT-01-230	30	61.8x43.7	10.1x13.7	345
KT-01-212	12	27.2x18.3	5.5x7.3	165	KT-01-232	32	65.8x46.4	10.4x14.3	365
KT-01-213	13	29.4x19.7	5.9x7.8	175	KT-01-233	33	69.5x48.8	10.7x15	392
KT-01-214	14	31.5x21.2	6.2x8.3	185	KT-01-234	34	69.5x48.8	10.7x15	392
KT-01-215	15	33.2x22.5	6.4x8.6	195	KT-01-235	35	74.0x53.0	13.5x19.4	422
KT-01-216	16	34.7x24.0	6.7x8.9	205	KT-01-236	36	74.0x53.0	13.5x19.4	422
KT-01-217	17	36.5x25.3	6.9x9.3	215	KT-01-238	38	77.0x56.0	15.0x20.4	442
KT-01-218	18	38.7x26.8	7.2x9.9	225	KT-01-241	41	84.0x61.0	16.0x21.6	472
KT-01-219	19	40.7x28.1	7.4x10.5	234	KT-01-243	43	84.0x61.0	16.0x21.6	472
KT-01-220	20	43.1x29.7	7.7x10.9	245	KT-01-244	44	92.0x66.0	17.0x23.0	512
KT-01-221	21	44.8x31.3	8.0x11.3	255	KT-01-246	46	92.0x66.0	17.0x23.0	512
KT-01-222	22	46.9x32.6	8.2x11.5	265	KT-01-248	48	102.0x73.0	18.0x24.6	552
KT-01-223	23	48.3x34.2	8.4x11.8	275	KT-01-250	50	102.0x73.0	18.0x24.6	552
KT-01-224	24	50.4x35.5	8.7x12.1	285					

Extra Long Combination Wrench

- DROP FORGED
- CHROME VANADIUM SEEL
- A. MIRROR POLISHED
- B. SATIN PLATED

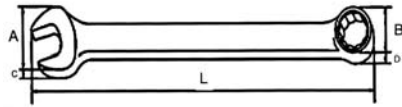

ART NO.	SIZE (mm)	L (mm)	A (mm)	B (mm)	C (mm)	D (mm)	Weight (g)
KT-2610L	10	189	22.8	15.8	5.1	6.9	53
KT-2611L	11	207	24.6	17.3	5.3	7.0	62
KT-2612L	12	225	27.2	18.8	5.6	7.8	77
KT-2613L	13	243	28.6	20.4	5.7	8.5	113
KT-2614L	14	261	31.4	21.8	6.9	9.1	128
KT-2615L	15	279	33.5	23.4	7.0	9.3	144
KT-2616L	16	297	35.3	24.8	7.3	10.0	182
KT-2617L	17	314	37.6	26.2	7.4	1.01	197
KT-2618L	18	333	39.4	27.5	7.8	11.3	223
KT-2619L	19	349	41.5	28.7	8.7	12.7	271

ART NO.	mm	Length (mm)
KT-02-607	7	138
KT-02-608	8	148
KT-02-609	9	160
KT-02-610	10	167
KT-02-611	11	186
KT-02-612	12	196
KT-02-613	13	205
KT-02-614	14	223
KT-02-615	15	233
KT-02-616	16	243
KT-02-617	17	262
KT-02-618	18	272
KT-02-619	19	281
KT-02-620	20	281
KT-02-621	21	301
KT-02-622	22	319
KT-02-623	23	339
KT-02-624	24	339
KT-02-625	25	373
KT-02-626	26	373
KT-02-627	27	388
KT-02-628	28	404
KT-02-629	29	404
KT-02-630	30	404
KT-02-632	32	431

POUCH BAG SET

ART NO.	SET	SIZE (mm)
KT-0110K	10PCS/PH	10, 11, 12, 13, 14, 15, 16, 17, 18, 19mm

Extra Long Double Ring Offset Wrench (0°)



MERTIC SIZE

ITME NO.	SIZE (mm)	C (mm)	B (mm)	C1 (mm)	B1 (mm)	T (mm)	L (mm)
KT-0810L	8x10	15.1	12.6	8.5	7.5	4.4	235
KT-1012L	10x12	19.1	16.2	9.1	8.4	4.6	295
KT-1214L	12x14	26.5	22.2	14.5	12.8	5.8	330
KT-1315L	13x15	26.5	22.2	14.5	12.8	5.8	330
KT-1417L	14x17	26.6	22.2	14.5	12.9	5.8	370
KT-1618L	16x18	29.3	26.6	16.0	15.0	7.0	405
KT-1719L	17x19	29.3	26.6	16.0	15.0	7.0	405
KT-1921L	19x21	29.3	31.0	17.0	16.0	7.0	405
KT-2224L	22x24	35.0	33.0	18.6	17.3	9.2	435

POUCH BAG SET

ART NO.	SET	SIZE (mm)
KT-0804K	4PCS/PH	10x12, 14x17, 17x19, 22x24mm
KT-0808K	8PCS/PH	8x10, 10x12, 12x14, 13x15, 14x17, 16x18, 17x19, 22x24mm

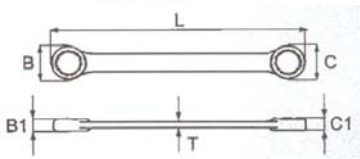

Double Ring Offset Wrench (0°)



- DROP FORGED
- CHROME VANADIUM SEEL
- A. MIRROR POLISHED
- B. SATIN PLATED

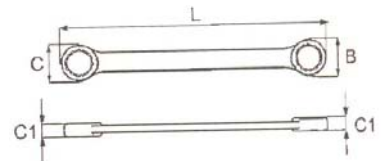

ART NO.	SIZE (mm)	A (mm)	B (mm)	C (mm)	L (mm)
KT-0607F	6x7	10.0	11.2	4.7	100
KT-0809F	8x9	12.5	14.0	5.2	115
KT-1012F	10x11	15.5	16.5	6.4	128
KT-1213F	12x13	18.5	20.5	7.3	143
KT-1415F	14x15	21.0	22.5	7.3	157
KT-1617F	16x17	23.5	24.5	8.5	168
KT-1719F	17x19	25.0	27.5	9.0	189
KT-1819F	18x19	26.0	27.5	9.2	189
KT-2123F	21x23	31.2	33.8	11.6	217
KT-2224F	22x24	31.2	33.8	11.6	217
KT-2628F	26x28	36.5	40.5	11.8	263
KT-2729F	27x29	38.8	43.5	12.8	285
KT-3032F	30x32	42.5	45.0	12.8	285

POUCH BAG SET

ART NO.	SET	SIZE (mm)
KT-0608K	8PCS/PH	6x7, 8x9, 10x11, 12x13, 14x15, 16x17, 18x19, 22x24mm
KT-0612K	12PCS/PH	6x7, 8x9, 10x11, 12x13, 14x15, 16x17, 18x19, 21x23, 22x24, 26x28, 27x29, 30x32mm

Offset 0° Double Torx Wrench

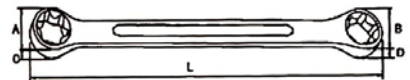

MERTIC SIZE

ART NO.	SIZE (mm)	A (mm)	B (mm)	C (mm)	D (mm)	L (mm)
KT-1608T	E6XE8	7.3	9.7	4.2	5.3	114
KT-1711T	E7XE11	10.8	14.8	5.2	7.2	130
KT-1012T	E10XE12	12.3	15.1	6.5	7.7	141
KT-1418T	E14XE18	17.0	21.1	8.2	10.3	180
KT-1622T	E16XE22	19.7	27.3	8.4	11.8	205
KT-2024T	E20XE24	23.9	27.9	11.0	12.6	224

POUCH BAG SET

ART NO.	SET	SIZE (mm)
KT-0604K	4PCS/PH	E6XE8, E7XE11, E10XE12, E14XE18, E16XE22, E20XE24mm

Double Ring Offset Wrench (75°)



- DROP FORGED
- CHROME VANADIUM SEEL
- A. MIRROR POLISHED
- B. SATIN PLATED

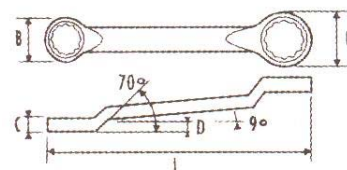

METRIC SIZE:

ART NO.	SIZE (mm)	B x B1 (mm)	C (mm)	D (mm)	L (mm)	ART NO.	SIZE (mm)	B x B1 (mm)	C (mm)	D (mm)	L (mm)
KT-08-203	6x7	10.7x12.2	5.7	6.3	168	KT-08-223	17x19	28.2x29.7	10.1	10.4	292
KT-08-204	6x8	10.7x12.2	5.7	6.3	168	KT-08-224	18x19	28.2x29.7	10.1	10.4	292
KT-08-205	8x9	13.6x15.1	6.7	7	183	KT-08-226	17x22	31.1x34.0	10.9	11.4	318
KT-08-206	8x10	13.6x15.1	6.7	7	183	KT-08-227	19x21	31.1x34.0	10.9	11.4	318
KT-08-207	9x11	16.6x18.0	7.4	7.7	198	KT-08-228	19x22	31.1x34.0	10.9	11.4	318
KT-08-208	10x11	16.6x18.0	7.4	7.7	198	KT-08-230	20x22	31.1x34.0	10.9	11.4	318
KT-08-209	10x12	16.6x18.0	7.4	7.7	198	KT-08-231	21x23	32.6x35.5	11.2	11.6	327
KT-08-211	11x13	19.5x20.9	8.1	8.4	217	KT-08-237	24x26	36.9x41.0	12.4	13.4	329
KT-08-212	12x13	19.5x20.9	8.1	8.4	217	KT-08-238	24x27	36.9x41.0	12.4	13.4	329
KT-08-213	12x14	19.5x20.9	8.1	8.4	217	KT-08-241	25x28	38.4x42.8	12.7	13.7	347
KT-08-218	14x15	22.4x23.7	8.8	9.1	239	KT-08-248	30x32	45.5x48.5	14.4	15.2	362
KT-08-219	14x17	22.4x23.7	8.8	9.1	239	KT-08-252	36x41	53.0x62.1	17.4	19.2	460
KT-08-220	15x17	25.3x26.7	9.5	9.8	260	KT-08-255	38x42	53.0x62.1	17.4	19.2	460
KT-08-221	16x17	25.3x26.7	9.5	9.8	260	KT-08-260	46x50	69.5x75.2	19.5	22.5	540

POUCH BAG SET

ART NO.	SET	SIZE (mm)
KT-0406K	6PCS	6x7, 8x9, 10x11, 12x13, 14x15, 16x17mm
KT-0407K	7PCS	6x7, 8x9, 10x11, 12x13, 14x15, 16x17, 18x19mm
KT-0408K	8PCS	6x7, 8x9, 10x11, 12x13, 14x15, 16x17, 18x19, 20x22mm
KT-0412K	12PCS	6x7, 8x9, 10x11, 12x13, 14x15, 16x17, 18x19, 20x22, 21x23, 24x27, 25x28, 30x32mm

Double Ring Offset Wrench (45°)



METRIC SIZE:

ART NO.	SIZE(mm)	L (mm)	C (mm)	B (mm)	ART NO.	SIZE(mm)	L (mm)	C (mm)	B (mm)
KT-08-704	6x8	165	10.6	13.0	KT-08-7021	16x17	237	24.0	26.0
KT-08-706	8x9	70	14.5	16.5	KT-08-7024	18x19	270	28.0	29.5
KT-08-707	8x10	170	14.5	16.5	KT-08-7030	20x22	292	29.0	32.5
KT-08-708	10x11	180	15.0	17.5	KT-08-7031	21x23	327	32.5	34.5
KT-08-709	10x12	195	17.2	19.2	KT-08-7034	22x24	327	32.5	34.5
KT-08-7012	12x13	206	20.0	22.0	KT-08-7037	24x26	362	34.5	36.5
KT-08-7013	12x14	206	20.0	22.0	KT-08-7041	25x28	372	39.8	42.4
KT-08-7018	14x15	232	22.0	24.0	KT-08-7048	30x32	392	43.5	45.0
KT-08-7019	14x17	232	22.0	25.0					

POUCH BAG SET

ART NO.	SET	SIZE (mm)
KT-0706K	6PCS	10x12, 12x14, 14x17, 17x19, 19x21, 22x24mm
KT-0708K	8PCS	6x7, 8x9, 10x11, 12x13, 14x15, 16x17, 18x19, 20x22mm

Flare Nut Wrench

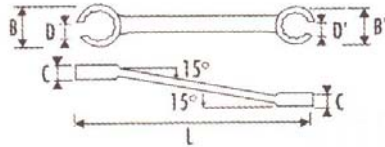

METRIC SIZE:

ART NO.	SIZE (mm)	B x B1 (mm)	CxC1 (mm)	DxD1 (mm)	L (mm)	ART NO.	SIZE (mm)	B x B1 (mm)	CxC1 (mm)	DxD1 (mm)	L (mm)
KT-05-606	8x9	18.0x20.0	7.0x8.5	6.0x7.0	145	KT-05-624	18x19	30.0x32.2	12.4x14.0	14.0x15.0	210
KT-05-607	8x10	18.0x20.0	7.0x8.5	6.0x7.0	145	KT-05-625	17x22	30.0x38.0	12.0x16.0	14.0x17.0	230
KT-05-608	10x11	20.0x22.0	8.5x9.0	7.0x8.5	152	KT-05-628	19x22	32.0x38.0	14.0x16.0	15.0x17.0	233
KT-05-609	10x12	20.0x22.2	8.5x9.0	7.0x9.0	152	KT-05-631	21x23	38.0x42.0	16.0x17.0	17.0x18.0	252
KT-05-611	11x13	22.0x26.0	9.0x10.5	8.5x10.0	165	KT-05-634	22x24	38.0x42.0	16.0x17.0	17.0x18.0	252
KT-05-612	12x13	22.0x26.0	9.0x10.5	8.5x10.0	165	KT-05-638	24x27	42.0x46.0	17.0x18.0	18.0x20.0	265
KT-05-613	12x14	24.0x28.0	9.5x11.0	9.0x11.0	178	KT-05-641	25x28	42.0x46.0	17.0x18.0	18.0x20.0	265
KT-05-614	13x14	24.0x28.0	9.5x11.0	9.0x11.0	178	KT-05-648	30x32	50.0x52.0	21.0x23.0	22.0x24.0	285
KT-05-619	14x17	28.0x30.0	11.0x12.0	11.0x14.0	16	KT-05-651	32x36	52.0x60.0	23.0x25.0	22.0x25.0	315
KT-05-621	16x17	28.0x30.0	11.0x12.0	11.0x14.0	196	KT-05-654	36x41	60.0x67.0	25.0x27.0	25.0x32.0	350
KT-05-623	17x19	30.0x32.2	12.0x14.0	14.0x15.0	210						

POUCH BAG SET

ART NO.	SET	SIZE (mm)
KT-0506KF	6PCS	8x10, 10x11, 11x13, 12x14, 17x19, 19x22mm
KT-0507KF	7PCS	8x10, 10x11, 11x13, 12x14, 17x19, 19x22, 24x27mm

6 Point Flare Nut Wrench Set



KT-520C-S6 , KT-520C-S4 → Satin Finish

KT-520C-M6, KT-520C-M4 → Mirror Finish

- For tube connections, union nuts and male fittings for pipes
- Heads bent 15°
- 6 point end slotted at 30°, 12 point end at 15°
- Chrome-Vanadium
- Surface chrome-plated.

ITEM NO.	SIZE (mm)	ITEM NO.	SIZE(mm)
KT-520C-089	8x9	KA-520C-1214	12x14
KT-520C-0810	8x10	KT-520C-1314	13x14
KT-520C-0911	9x11	KT-520C-1415	14x15
KT-520C-1012	10x12	KT-520C-1517	15x17
KT-520C-1113	11x13	KT-520C-1618	16x18
KT-520C-1213	12x13	KT-520C-1719	17x19

ART NO.	SET	SIZE (mm)
KT-520C-S6 KT-520C-M6	6PCS	8x10, 10x12, 11x13, 12x14, 15x17, 17x19mm
KT-520C-S4 KT-520C-M4	4PCS	8x10, 10x12, 13x14, 15x17mm

Starter & Block Wrench



ART NO.	SIZE (mm)	A (mm)	B (mm)	C (mm)	D (mm)	L (mm)	Weight (g)
KT-0812B	10x12	15.6	17.9	7	6.6	142	57
KT-0813B	11x13	17.9	20.7	8.0	8.2	164	90
KT-0815B	14x17	21.4	25.1	8.2	9.2	190	133
KT-0817B	15x17	24.8	27.7	8.8	9.6	216	166
KT-0818B	16x18	24.8	27.7	8.8	9.6	216	166
KT-0822B	19x22	27.6	33.0	10.0	11.1	255	244

ART NO.	SET	SIZE (mm)
KT-0805K	5PCS/PH	10x12, 11x13, 14x17, 16x18, 19x22mm

72 Tooth Gear Wrench



- DROP FORGED
- CHROME VANADIUM SEEL
- A. MIRROR POLISHED
- B. SATIN PLATED

ART NO.	SIZE (S1) (mm)	O1 (mm)	O2 (mm)	T1 (mm)	T2 (mm)	B1 (mm)	W1 (mm)	L1 (mm)
KT-0110G	10mm	20.4	22.2	5.0	9	9.5	3.6	162
KT-0111G	11mm	21.5	23.5	5.5	9	10.0	4.0	164
KT-0112G	12mm	24.5	25.3	5.5	9	11.2	4.2	170
KT-0113G	13mm	26.6	26.5	6.0	9	11.8	4.2	180
KT-0114G	14mm	29.1	30.3	6.0	10	12.5	4.5	191
KT-0115G	15mm	31.1	31.0	6.5	10	13.2	4.6	201
KT-0116G	16mm	33.2	31.8	7.0	10	14.0	4.6	210
KT-0117G	17mm	34.8	35.0	7.0	11	14.6	5.3	225
KT-0118G	18mm	36.8	35.5	8.0	11	15.7	5.8	238
KT-0119G	19mm	38.8	36.0	9.0	11	16.8	6.3	247

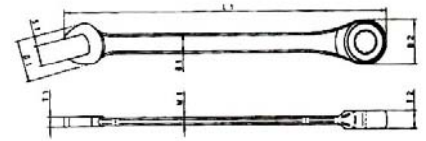

21PC - 72 Tooth Gear Wrenches & Go-Through-Socket Set

ART NO.	Q'TY	CONTAINS & SIZE
KT-0110GK	10PCS	72 Tooth gear wrenches 10, 11, 12, 13, 14, 15, 16, 17, 18, 19mm
	10PCS	Go Through & Hexagon Dr. Socket 10, 11, 12, 13, 14, 15, 16, 17, 18, 19mm
	1PC	Steel Case



Go-through & Hexagon Drive Socket

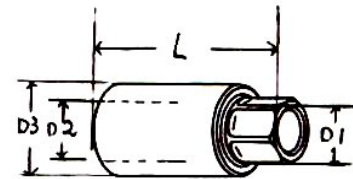

ART NO.	SIZE (mm)	D1 (mm)	D2 (mm)	D3 (mm)	L (mm)
KT-6610T	10	10	10	15.3	35
KT-6611T	11	11	11	16.3	35
KT-6612T	12	12	12	17.8	35
KT-6613T	13	13	13	18.8	35
KT-6614T	14	14	14	19.8	37
KT-6615T	15	15	15	21.8	37
KT-6616T	16	16	16	22.8	37
KT-6617T	17	17	17	24.4	39
KT-6618T	18	18	18	25.8	39
KT-6619T	19	19	19	26.6	39

Combination Wrench – Open & Socket End

- DROP FORGED
- CHROME VANADIUM SEEL
- A. MIRROR POLISHED
- B. SATIN PLATED



MERTIC SIZE

ART NO.	SIZE (mm)	L (mm)	B (mm)	D (mm)	S1 (mm)	S2 (mm)
KT-03-208	8	169	19	13	6.2	13
KT-03-209	9	169	19	14	6.2	14
KT-03-210	10	180	20.5	14.7	6.4	14.7
KT-03-211	11	192	24.7	15.8	6.6	15.8
KT-03-212	12	192	24.7	17.7	6.6	17.7
KT-03-213	13	210	28.3	19	7.1	19
KT-03-214	14	228	32.6	20	7.1	20
KT-03-215	15	238	33.4	21.8	7.2	21.8
KT-03-216	16	238	33.5	23.8	7.5	23.8
KT-03-217	17	235	35.6	23.8	7.5	23.8
KT-03-218	18	255	41.1	26	8.5	26
KT-03-219	19	255	41.1	26	8.5	26

POUCH BAG SET

ART NO.	SET	SIZE (mm)
KT-0307K	7PCS/PH	8, 10, 12, 13, 14, 17, 19mm
KT-0317K	7PCS/PH	9, 10, 12, 13, 14, 17, 19mm

Flexible Double Socket Wrench



MERTIC SIZE

ART NO.	SIZE (mm)	L (mm)	B (mm)	D (mm)	S1 (mm)	S2 (mm)
KT-03-607	6x7	180	10.9	10.9	180	180
KT-03-809	8x9	182	13.8	13.8	182	182
KT-03-111	10x11	202	15.9	15.9	202	202
KT-03-123	12x13	224	18.7	18.7	224	224
KT-03-145	14x15	241	21.8	21.8	241	241
KT-03-167	16x17	258	23.8	23.8	258	258
KT-03-189	18x19	173	25.8	25.8	273	273
KT-03-222	20x22	173	30.9	30.9	273	273
KT-03-223	21x23	303	32.6	32.6	303	303

POUCH BAG SET

ART NO.	SET	SIZE (mm)
KT-0907K	7PCS/PH	6x7, 8x9, 10x11, 12x13, 14x15, 16x17, 18x19mm
KT-0917K	7PCS/PH	8x9, 10x11, 12x13, 14x15, 16x17, 18x19, 20x22mm
KT-0909K	9PCS/PH	6x7, 8x9, 10x11, 12x13, 14x15, 16x17, 18x19, 20x22, 21x23mm



KA-T10008K LED Spanner with 72 Tooth Gear Wrench

- Battery: No. CR626, SR626, AG4, LR626, 377A, A177 1.5V
- Maximum out-put is two or three hours, Normal use until no light is 120 hours.
- LED light: Effective function time is 30,000 hours.
- Have to wiped the mess after using in water or oil, as it isn't overall water-proof
- Size: 8-10-11-12-13-14-15-16-17-19mm

Item No.	Size
KA-T10008	8MM
KA-T10010	10MM
KA-T10011	11MM
KA-T10012	12MM
KA-T10013	13MM

Item No.	Size
KA-T10014	14MM
KA-T10015	15MM
KA-T10016	16MM
KA-T10017	17MM
KA-T10019	19MM



KA-T10001K
4PCS: 10, 13, 17, 19mm



KA-T10002K
7PCS: 8, 10, 13, 14, 15, 17, 19mm



KA-T10003K
5PCS: 8, 10, 11, 12, 13mm



KA-T10004K
10PCS: 8, 10, 11, 12, 13, 14, 15, 16, 17, 19mm

LED Lighting Ratchet Wrench



Item No.	Description
KA-T10006-41	10mm LED Light Ratchet Wrench ■ 1/4" Dr. x 10mm adaptor · 1/4"Dr. x 10mm Hex Bit
KA-T10006-83	13mm LED Light Ratchet Wrench ■ 3/8" Dr. x 13mm adaptor · 3/8"Dr. x 13mm Hex Bit
KA-T10006-21	19mm LED Light Ratchet Wrench ■ 1/2" Dr. x 19mm adaptor · 1/2"Dr. x 19mm Hex Bit
KA-T10006K	9pcs LED Light Ratchet Wrench (10, 13, 19mm) ■ 1/4", 3/8", 1/2" Dr. x 10, 13, 19 mm adaptor ■ 1/4", 3/8", 1/2" Dr. x 10, 13, 19mm Hex Bit



KA-T10005K 6pcs LED Lighting Ratchet Wrench

- Contents:**
- Size: 8, 10, 12, 13, 17, 19mm
 - Quick release adaptor: 1/4", 3/8", 1/2"
 - Hex bit: 1/4"

LED Extension Bar



ITEM NO.	Size
KA-T10007-3	1/2(M) x 1/2(F) x 3"
KA-T10007-5	1/2(M) x 1/2(F) x 5"
KA-T10007-10	1/2(M) x 1/2(F) x 10"
KA-T10007K	1/2(M) x 1/2(F) x 3", 5", 10"



Wobble LED Extension Bar

ITEM NO.	Size
KA-T20007-3	1/2(M) x 1/2(F) x 3"
KA-T20007-5	1/2(M) x 1/2(F) x 5"
KA-T20007-10	1/2(M) x 1/2(F) x 10"
KA-T20007K	1/2(M) x 1/2(F) x 3", 5", 10"





KA-1614 16pcs 3/4" & 1" Dr. Insert Bit Socket Set

- 5- TX Star: T60-T70-T80-T90-T100
- 4- Hexagon: 17-19-22-24mm
- 1- Star -E: E18-E20-E22-E24
- 1- Adaptor: 3/4"Dr.
- 1- Adaptor: 1"
- 1- Hexagon L-Key: 4mm

KA-1333 6pcs 1/2" Dr. Integral Spline Bit Socket Set

- One-Piece (Integral)
- 6pcs Spline
- Length: 30mmL
- Size: M10-M12-M14-M16-M18-M20



KA-1334 6pcs 1/2" Dr. Integral Torx Bit Socket Set

- One-Piece (Integral)
- 6pcs Torx (tamper)
- Length: 30mmL
- Size: T55H-T60H-T70H-T80H-T90H-T100H



LED Light Plier

Specification:

- Material: CR-MO
- Hardness of blade: 55-60 degree
- Hardness of body: 48-52 degree
- Surface: Phosphate (black)
- Battery: LR626



KA-T30001
8" LED Combination Plier
- 200mm



KA-T30002
7" LED Diagonal Plier
- 190mm



KA-T30003
8" LED Long Nose Plier
- 213mm



Drive Rotor Stubby Ratchet (3/8" & 1/4" BIT)

ITEM	TYPE	D(mm)	T(mm)	TEETH	L	G	PCS	GW(kgs)
KT-372BGLS-1	3/8"	44	39.5	72	168mm	360g	60	22.5/0.6



3/8" & 1/4" 17 Penetrable Drive Rotor Stubby Ratchet

ITEM	TYPE	D(mm)	T(mm)	TEETH	L	G	PCS	GW(kgs)
KT-37217GLS	3/8"	44	15	72	165mm	300g	60	19/0.6
KT-27211GLS	1/4"	31.5	11	72	100mm	140g	100	15/0.6



Drive Rotor Stubby Ratchet (1/2" & 1/4" . 3/8" & 1/4")

ITEM	TYPE	D(mm)	T(mm)	TEETH	L	G	PCS	GW(kgs)
KT-4722GLS	1/2"	44	47	72	160mm	360g	60	22/0.6
KT-3722GLS	3/8"	44	43	72	160mm	360g	60	22/0.6



1/2" & 3/8" Drive Rotor Stubby Ratchet

ITEM	TYPE	D(mm)	T(mm)	TEETH	L	G	PCS	GW(kgs)
KT-472GLS	1/2"	44	36	72	160mm	360g	60	22/0.6
KT-372GLS	3/8"	44	32	72	160mm	360g	60	22/0.6



Drive Rotor Stubby Ratchet (3/8" & 1/4" BIT)

ITEM	TYPE	D(mm)	T(mm)	TEETH	L	G	PCS	GW(kgs)
KT-372BGLS	3/8"	44	38	72	160mm	360g	60	22/0.6



72T Drive Rotor Stubby Ratchet (1/2" & 3/8" , 3/8" & 1/4")

ITEM	TYPE	D(mm)	T(mm)	TEETH	L	G	PCS	GW(kgs)
KT-4723G	1/2"	39.5	51	72	260mm	600g	40	24.5/1.1
KT-3722G	3/8"	32	37.5	72	196mm	280g	60	18/0.6



1/2" & 3/8" 72T Drive Rotor Stubby Ratchet

ITEM	TYPE	D(mm)	T(mm)	TEETH	L	G	PCS	GW(kgs)
KT-472GLS-1	1/2"	44	40	72	168mm	360g	60	22.5/0.6
KT-372GLS-1	3/8"	44	40	72	168mm	360g	60	22.5/0.6



1/2" & 3/8" & 1/4" Reversible Ratchet Handle with Quick Release

ITEM	TYPE	D(mm)	T(mm)	TEETH	L	G	PCS	GW(kgs)
KT-472GQ	1/2"	40	40.5	72	257mm	580g	40	24/1.2
KT-372GQ	3/8"	32	32	72	195mm	280g	60	18/0.7
KT-272GQ	1/4"	25.5	23.5	72	147mm	140g	100	15/0.6



1/2" & 3/8" & 1/4" Reversible Ratchet Handle with Quick Release

ITEM	TYPE	D(mm)	T(mm)	TEETH	L	G	PCS	GW(kgs)
KT-472PQ	1/2"	40	40.5	36	255mm	640g	40	26/1.2
KT-372PQ	3/8"	32	32	36	180mm	350g	60	21.5/1.2
KT-272PQ	1/4"	25.5	23.5	36	125mm	140g	100	14.5/1.2



1/2" & 3/8" & 1/4" Rotor Ratchet

ITEM	TYPE	D(mm)	T(mm)	TEETH	L	G	PCS	GW(kgs)
KT-472PL	1/2"	49	41	72	280mm/11"	700g	32	23.5/1.2
KT-372PL	3/8"	43	31	72	220mm/8-1/2"	410g	60	25.5/1.2
KT-272PL	1/4"	32	23	72	140mm/5-1/2"	120g	100	13/1.2



1/2" & 3/8" & 1/4" (19-17-11) Penetrable Drive Rotor Ratchet

ITEM	TYPE	D(mm)	T(mm)	TEETH	L	G	PCS	GW(kgs)
KT-47219GL	1/2"	49	17	72	305mm	560g	32	19/1.2
KT-37217GL	3/8"	44	15	72	250mm	380g	60	23.5/1.2
KT-27211GL	1/4"	31	11	72	160mm	150g	100	16/1.2



1/2" & 3/8" & 1/4" (19-17-11) Penetrable Drive Rotor Ratchet

ITEM	TYPE	D(mm)	T(mm)	TEETH	L	G	PCS	GW(kgs)
KT-47219PL	1/2"	49	17	72	280mm	680g	32	22.5/1.2
KT-37217PL	3/8"	44	15	72	168mm	360g	60	22.5/1.1
KT-27211PL	1/4"	31	11	72	145mm	140g	100	15/0.6



1/2" & 3/8" & 1/4" Flex Head Ratchets

ITEM	TYPE	D(mm)	T(mm)	TEETH	L	G	PCS	GW(kgs)
KT-472GR	1/2"	49	41	72	430mm/16-1/2"	860g	30	26/1.3
KT-372GR	3/8"	43	31	72	250mm/9-1/2"	400g	60	24.5/1.2
KT-272GR	1/4"	32	23	72	190mm/7"	160g	100	16.5/1.2



1/2" & 3/8" & 1/4" Flex Head Ratchets

ITEM	TYPE	D(mm)	T(mm)	TEETH	L	G	PCS	GW(kgs)
KT-472PR	1/2"	49	41	72	400mm/15.5"	880g	20	18/1.2
KT-372PR	3/8"	43	31	72	230mm/8-1/2"	370g	60	22.5/1.2
KT-272PR	1/4"	32	23	72	170mm/6-1/2"	165g	100	17/1.2



1/2" & 3/8" & 1/4" Rotor Ratchet

ITEM	TYPE	D(mm)	T(mm)	TEETH	L	G	PCS	GW(kgs)
KT-472GL	1/2"	49	41	72	320mm/12"	690g	32	22.5/1.2
KT-372GL	3/8"	43	31	72	250mm/9-1/2"	400g	60	24.5/1.2
KT-272GL	1/4"	32	23	72	165mm/6"	130g	100	13.5/1.2



1" & 3/4" Reversible Ratchet Handle with Quick Release

ITEM	TYPE	D(mm)	T(mm)	TEETH	L	G	PCS	GW(kgs)
KT-848NR	1"	70	66	48	760mm	3800g	6	23/1.5
KT-648NR	3/4"	70	66	48	530mm	3100g	6	19/1.5



1/2" & 3/8" & 1/4"

Reversible Ratchet Handle with Quick Release (PUSH)

ITEM	TYPE	D(mm)	T(mm)	TEETH	L	G	PCS	GW(kgs)
KT-448PQ	1/2"	43	40	48	251mm/10"	640g	32	20.5/1.3
KT-348PQ	3/8"	31	31	48	199mm/8"	315g	60	19.5/1.2
KT-248PQ	1/4"	25	24	48	140mm/5-1/2"	145g	10	15/1.2



3/8" Flex Head Ratchets

ITEM	TYPE	D(mm)	T(mm)	TEETH	L	G	PCS	GW(kgs)
KT-348PR	3/8"	32	33	48	235mm/9-1/4"	380g	50	20/1.2



1/2" & 3/8" & 1/4" Reversible Ratchet Handle with Quick Release (PUSH)

ITEM	TYPE	D(mm)	T(mm)	TEETH	L	G	PCS	GW(kgs)
KT-448GQ	1/2"	43	40	48	263mm/10"	640g	40	26/1.2
KT-348GQ	3/8"	32	31	48	199mm/8"	310g	60	19/1.2
KT-248GQ	1/4"	25	24	48	147mm/5-1/2"	145g	100	15/1.2



1/2" Reversible Ratchet Handle with Quick Release

ITEM	TYPE	D(mm)	T(mm)	TEETH	L	G	PCS	GW(kgs)
KT-436NQ-1	1/2"	39.5	40	36	380mm	880g	25	23/0.6



1/2" Reversible Ratchet Handle with Quick Release

ITEM	TYPE	D(mm)	T(mm)	TEETH	L	G	PCS	GW(kgs)
KT-436PQ-1	1/2"	39.5	40	36	380mm	880g	25	23/0.6



1/2" Reversible Ratchet Handle with Quick Release

ITEM	TYPE	D(mm)	T(mm)	TEETH	L	G	PCS	GW(kgs)
KT-436GQ-1	1/2"	39.5	40	36	410mm	880g	25	23/0.6



1/2" & 3/8" & 1/4" Reversible Ratchet Handle with Quick Release (PUSH)

ITEM	TYPE	D(mm)	T(mm)	TEETH	L	G	PCS	GW(kgs)
KT-436PQ	1/2"	40	40.5	36	255mm	640g	40	26/1.2
KT-336PQ	3/8"	32	32	36	180mm	350g	60	21.5/1.2
KT-236PQ	1/4"	25.5	23.5	36	125mm	140g	100	14.5/1.2



1/2" & 3/8" & 1/4" Reversible Ratchet Handle with Quick Release (PUSH)

ITEM	TYPE	D(mm)	T(mm)	TEETH	L	G	PCS	GW(kgs)
KT-436GQ	1/2"	40	40.5	36	255mm	600g	40	4.5/1.2
KT-336GQ	3/8"	32	32	36	200mm	350g	60	21.5/1.2
KT-236GQ	1/4"	25.5	23.5	36	142mm	140g	100	14.5/1.2



1/2" Extension Ratchet Handle

ITEM	TYPE	D(mm)	T(mm)	TEETH	L	G	PCS	GW(kgs)
KT-424NR	1/2"	45	33	24	15"/20"	1000g	20	20.5/1
KT-436NR	1/2"	40	40.5	36	15"/24"	1160g	20	24/1



1/2" & 3/8" & 1/4" Reversible Ratchet Handle with Quick Release (PUSH)

ITEM	TYPE	D(mm)	T(mm)	TEETH	L	G	PCS	GW(kgs)
KT-424N	1/2"	45	36.5	24	250mm/10"	620g	40	24.8/0.5
KT-324N	3/8"	35	32	24	190mm/8"	320g	70	22.5/0.5
KT-224N	1/4"	26	24	24	129mm/5"	120g	100	12.5/0.5



1/2" & 3/8" & 1/4" Reversible Ratchet Handle with Quick Release (PUSH)

ITEM	TYPE	D(mm)	T(mm)	TEETH	L	G	PCS	GW(kgs)
KT-424PQ-1	1/2"	46.5	41	24	265mm/10"	780g	30	23.5/0.5
KT-324PQ	3/8"	35	31	24	197mm/8"	330g	70	23.1/0.5
KT-224PQ	1/4"	27	23.5	24	143mm/5-1/2"	135g	100	13.5/0.5



1/2" & 3/8" & 1/4" Reversible Ratchet Handle with Quick Release (PUSH)

ITEM	TYPE	D(mm)	T(mm)	TEETH	L	G	PCS	GW(kgs)
KT-4242GQ-1	1/2"	46.5	41	24	276mm/10-1/2"	700g	32	23/1.2
KT-3242GQ	3/8"	35	31	24	214mm/8-1/2"	320g	60	19.5/1.2
KT-242GQ	1/4"	26.5	23.5	24	140mm/10"	140g	100	14.5/1.2
KT-4242GQ-2	1/2"	45.5	36.5	24	266mm/10"	600g	40	24.5/1.2



3/4" Reversible Ratchet Handle with Quick Release (PUSH) HANDLE ALL STEEL Ø 24mm

ITEM	TYPE	D(mm)	T(mm)	TEETH	L	G	PCS	GW(kgs)
KT-624NQ	3/4"	46	61	24	510mm/20"	2600g	10	26.5/1.2
KT-624N	3/4"	64	55	24	510mm/20"	2600g	10	26.5/1.2



1" & 3/4" Reversible Ratchet Handle with Quick Release (PUSH) HANDLE STEEL PIPE Ø 32mm

ITEM	TYPE	D(mm)	T(mm)	TEETH	L	G	PCS	GW(kgs)
KT-824NR	1"	70	66	24	800mm	4150g	6	25.5/1.3
KT-624QR	3/4"	64	61	24	510mm/20"	2710g	10	27.5/1.2
KT-624NR	3/4"	64	55	24	510mm/20"	2710g	10	27.5/1.2



1" Reversible Ratchet Handle HANDLE ALL STEEL Ø 28mm

ITEM	TYPE	D(mm)	T(mm)	TEETH	L	G	PCS	GW(kgs)
KT-824	1"	70	66	24	670mm	4400g	6	27/1.3



1/2" Swivel Handle

ITEM	TYPE	L	G	PCS	GW(kgs)
KT-4300	1/2"	300mm	635g	40	25.5/0.6
KT-4335	1/2"	431mm	900g	20	20.5/0.6



1/2" High Handle

ITEM	TYPE	D(mm)	L	G	PCS	GW(kgs)
KT-4240G	1/2"	31	620mm	1000g	20	20/0.7



1" & 3/4" & 1/2" Sliding T-Handle

ITEM	TYPE	D(mm)	T(mm)	L	G	PCS	GW(kgs)
KT-8760	1"	49	83	760mm/30"	4300g	6	25.8/1.3
KT-6510	3/4"	39.5	64.5	510mm/20"	1580g	15	24/1.1
KT-4250	1/2"	24	41	250mm/10"	360g	50	18.5/0.5



1/2" Swivel Handle

ITEM	TYPE	L	G	PCS	GW(kgs)
KT-4320	1/2"	380mm	750g	20	15/0.6



1" & 3/4" High Handle

ITEM	TYPE	D(mm)	T(mm)	L	G	PCS	GW(kgs)
KT-8850F	1"	55	69	800mm	3850g	6	31.5/1.5
KT-6560F	3/4"	43	59	560mm	2400g	10	21/1.5



3/4" High Handle

ITEM	TYPE	D(mm)	T(mm)	L	G	PCS	GW(kgs)
KT-6240N	3/4"	43	59	620mm	2300g	10	23.5/1.5



KA-1336A / KA-1336B

Torque Screwdriver With Window Scale

- KA-1336A Torque 1~5 Nm(5~50 inch-pounds)
- KA-1336B Torque 2~10 Nm(10~80 inch-pounds)
- KA-1336C Torque 4~12 Nm(30~90 inch-pounds)



Include 32-bits and 1-bit holder

- KA-1336AK 1~5Nm
- KA-1336BK 2~10Nm



KA-1336C

Mechanical Digital Display Torque Wrench



Item No.	KA-1335A	KA-1335B	KA-1335C (KA-1335CR)
Drive	1/4"	3/8"	1/2"
Net Weight	840g	950g	1220g
Tool Length	390mm	390mm	490mm
Head Depth	31.8mm	35.7mm	43.2mm
Head Width	35.1mm	35.1mm	38.7mm
Display Range	10 – 50 N-m	20 – 100 N-m	40 – 200 N-m
Accuracy	±3%	±3%	±3%
Unit Selection	Kg-cm, Kg-m, In-lb, Ft-lb, N-m		
Battery	3 Volt Battery CR2032		



KA-1624 / KA-1626 Digital Torque Wrench

- 50 Memory Record
- Target Value Setting
- Peak and Trace mode
- 5 unit set: (N-m, ft-lt, in-lb, kg-m, kg-cm)
- Auto Off: 80 seconds (if do not use ratchet)
- 36T quick release

Specifications:

Model No.	KA-1624	KA-1626
Range	16-80Nm (11.8~59.0lb-ft)	27-135Nm (19.9-99.6lb-ft)
Length	280mm	310mm
Accuracy	±3%	±2%
Dr.	1/4"	3/8"
Battery	CR2032 x 1pc	AA x 2pcs
Battery life	55hrs(continuous operation)	110hrs(continuous operation)



KA-1627 1/2" Dr. Digital Torque Wrench

- 50 Memory Record
- Target Value Setting
- Peak and Trace mode
- 5 unit set: (N-m, ft-lt, in-lb, kg-m, kg-cm)
- Auto Off: 120 seconds (if do not use ratchet)
- 36T quick release
- Alarm: Buzzer & LED
- LED alarm indicator 3pcs

Specifications:

Model No.	KA-1627
Range	40-200Nm (29.5~147.5lb-ft)
Length	480mm
Accuracy	±2%
Dr.	1/2"
Battery	AAA x 3pcs
Battery life	110hrs(continuous operation)



Jumbo LCD



3pcs LED alarm indicator
3 directions alarm LED



KA-1626F5 / KA-1627F5 5 IN 1 Pre-Fixed Digital Torque Wrench

- Pre-Fixed value: 90. 110. 135. 160. 190Nm Or 65. 80. 100. 120. 140 ft-lb
- Unit set: N-m or lb-ft only
- Auto Off: 120 seconds (if do not use ratchet)
- Drive and LCD vertical
- Alarm: Buzzer & LED
- LED alarm indicator 3pcs
- Accuracy: ±2%
- Length: 480mm

Model No.	Range	Dr.
KA-1626F5	40-200Nm (29.5~147.5lb-ft)	3/8"
KA-1627F5	27-135Nm (19.9~99.6lb-ft)	1/2"



Digital Ratchet Wrench

Specifications:

Model No.	Length	Dr.	Range	Accuracy
KA-1628	210mm	1/4"	6-30N-m(4.4-22.1lb-ft)	±3%

- 50 Memory Record
- Target Value Setting
- Peak and Trace mode
- 5 unit set: (N-m, ft-lt, in-lb, kg-m, kg-cm)
- Auto Off: 80seconds
- Battery: CR2032 x 1pc
- 36T quick release

82pcs Professional-Threaded Coil-Insert Repair Kit



- 1) Coil: Material: Stainless Steel SUS304,HRC43°~50°
- 2) Tapping: Material: SKH9
Heat Treatment: 64°~65°
- 3) Pin Puncher: Material: Middle Carbon Steel
Surface Treatment: Heat Treatment 40°~50°
With Black Finished
- 4) Coil-Installation Shanks: Material: Middle Carbon Steel
Surface Treatment: Heat Treatment 45°~48°
With Black Finished
- 5) Installation Tool
Material:
1. Across Bar on the top ..Middle Carbon Steel
2. Outside Body. Aluminum anodize and Black Plated
3. The axis of the tool. Aluminum anodize and Black Plated
- 6) Coil Shielding Collar: Material: Aluminum anodize and Black Plated
- 7) Hexagonal wrench: Material: iron

KA-1280S (For UNC Spec.)



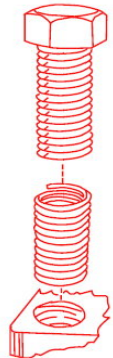

1/4-20*1.5D-Screw-coil thread	25 pcs
1/4-20-Tapping tool	1 pcs
1/4-20-Pin Puncher	1 pcs
1/4-20-Coil-Installation Shanks tool	1 pcs
1/4-20-Coil Shielding Collar	1 pcs
5/16-18*1.5D-Screw-coil thread	15pcs
5/16-18-Tapping tool	1 pcs
5/16-18-Pin Puncher	1 pcs
5/16-18-Coil-Installation Shanks tool	1 pcs
5/16-18-Coil Shielding Collar	1 pcs
3/8-16*1.5D-Screw-coil thread	10 pcs
3/8-16-Tapping tool	1 pcs
3/8-16-Pin Puncher	1 pcs
3/8-16-Coil-Installation Shanks tool	1 pcs
3/8-16-Coil Shielding Collar	1 pcs
7/16-14*1.5D-Screw-coil thread	6 pcs
7/16-14-Tapping tool	1 pcs
7/16-14-Pin Puncher	1 pcs
7/16-14-Coil-Installation Shanks tool	1 pcs
7/16-14-Coil Shielding Collar	1 pcs
1/2-13*1.5D-Screw-coil thread	4 pcs
1/2-13-Tapping tool	1 pcs
1/2-13-Pin Puncher	1 pcs
1/2-13-Coil-Installation Shanks tool	1 pcs
1/2-13-Coil Shielding Collar	1 pcs
Installation Tool	1 pcs
Haxagonal wrench	1 pcs

KA-1280M (M5.M6.M8.M10.M12)

M5-0.8*1.5D-Screw-coil thread	25 pcs
M5-0.8-Tapping tool	1 pcs
M5-0.8-Pin Puncher	1 pcs
M5-0.8-Coil-Installation Shanks tool	1 pcs
M5-0.8-Coil Shielding Collar	1 pcs
M6-1.0*1.5D-Screw-coil thread	15 pcs
M6-1.0-Tapping tool	1 pcs
M6-1.0-Pin Puncher	1 pcs
M6-1.0-Coil-Installation Shanks tool	1 pcs
M6-1.0-Coil Shielding Collar	1 pcs
M8-1.25*1.5D-Screw-coil thread	10 pcs
M8-1.25-Tapping tool	1 pcs
M8-1.25-Pin Puncher	1 pcs
M8-1.25-Coil-Installation Shanks tool	1 pcs
M8-1.25-Coil Shielding Collar	1 pcs
M10-1.5*1.5D-Screw-coil thread	6 pcs
M10-1.5-Tapping tool	1 pcs
M10-1.5-Pin Puncher	1 pcs
M10-1.5-Coil-Installation Shanks tool	1 pcs
M10-1.5-Coil Shielding Collar	1 pcs
M12-1.75*1.5D-Screw-coil thread	4 pcs
M12-1.75-Tapping tool	1 pcs
M12-1.75-Pin Puncher	1 pcs
M12-1.75-Coil-Installation Shanks tool	1 pcs
M12-1.75-sCoil Shielding Collar	1 pcs
Installation Tool	1 pcs
Haxagonal wrench	1 pcs



Step by Step Drilling → Tapping → Installation → Break-off Pin

1.		Drilling Drill out the damaged threads using the drill. Drill to sufficient depth to accommodate the insert length and bolt or screw being used.	3.		Adjust You can set up the depth you want to insert the coil into the hole by locking the tool.
2.		Tapping Use the Heil-Coil Tap. Check the size on your shank to make sure you have the right one. Tap the hole to sufficient depth to accommodate the insert length and bolt or screw being used.	5.		Remove The driving tangs of coil inserts should be removed to eliminate their interference with the end of the assembled bolt. Their removal provides greater latitude in the depth location of the bolt.
4.		Install (1) Use the specified installation tool. (2) Just wind the insert into the hole until the top coil is 1/4-1/2 turn into the tapped thread.			

KA-1281
8pcs Professional-Threaded Coil-Insert Repair Kit
(M14-1.25)



Content

M14-1.25*1.5D-Screw-coil thread	4 pcs
M14-1.25-Tapping tool	1 pcs
M14-1.25-Pin Puncher	1 pcs
M14-1.25-Coil-Installation Shanks tool	1 pcs
Stubby ratchet screwdriver [Black and Red handle]	1 pcs

- 1) Coil:
Material: Stainless Steel SUS304,HRC43°~50°
- 2) Tapping:
Material: SKH9
Heat Treatment: 64°~65°
- 3) Pin Puncher:
Material: Middle Carbon Steel
Surface Treatment: Heat Treatment 40°~50°
With Black Finished
- 4) Coil-Installation Shanks:
Material: Middle Carbon Steel
Surface Treatment: Heat Treatment 45°~48°
With Black Finished
- 5) Ratchet Screwdriver:
Material: PP & TPR Handle Grip
CR-V Steel Shaft

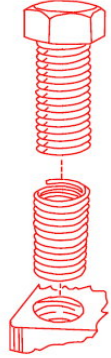

Step of using

1.		<p>Drilling Drill out the damaged threads using the drill. Drill to sufficient depth to accommodate the insert length and bolt or screw being used.</p>	5.		<p>Install the Coil Wind the coil insert into the hole until the depth-stop to get stuck by ratchet screwdriver.</p>
2.		<p>Tapping Use the Heil-Coil Tap. Check the size on your shank to make sure you have the right one. Tap the hole to sufficient depth to accommodate the insert length and bolt or screw being used.</p>			
3.		<p>Assembling Tools Choose the coil-installation shank size that you're going to use and are suitable for coil, insert the coil-installation shank into ratchet screwdriver at first.</p>	6.		<p>The driving tangs of coil inserts should be punched to eliminate their interference with the end of the assembled bolt. Their removal provides greater latitude in the depth location of the bolt.</p>
4.		<p>Assembling Coil Pick one coil and install it into the coil-installation shank; please notice if you put the tang of coil into the "U" shape of the coil-installation shank.</p>			



KA-5200 / KA-5200A



KA-5200K / KA-5200AK



KA-5200ST

10 low profile socket

8,9,10,11,12,13,14,15,16,17mm.

Ratchet Extension Drive Bar (1/4" ~ 3/8")

- 340mm / 13.4" length extension drive bar enables work in confined spaces easier.
- Provided with two square drive adapters in 1/4" and 3/8".
- Chain-driven mechanism enhances working durability and smoothness.

Specifications:

- Drive Bar Material: Aluminum
- Drive Bar Surface: chrome Plating
- Adapter Material: SCM 440
- Adapter Surface: Phosphate Manganese
- Adapter Hardness: HRC 42-45



KA-5200 Max torque: 71.87Nm/53ft.lb

KA-5200A Max torque: 161Nm/118.7ft.lb.

Instruction:

For Loosening

1. Use a standard wrench to loosen the fastener.
2. Choose a suitable adapter (1/4" or 3/8") and fit on one end of the extension bar.
3. Connect a 3/8" ratchet wrench and fit on the other end of the extension bar for removing the fastener.

For Tightening

1. Choose a suitable adapter (1/4" or 3/8") and fit on one end of the extension bar
2. Connect a 3/8" ratchet wrench and fit on the other end of the extension bar for tightening the fastener
3. Use a standard wrench to tighten the fastener with adequate torque



KA-5200K & KA-5200AK,

Includes 10 low profile socket 8,9,10,11,12,13,14,15,16,17mm.

KA-5200K Max torque: 71.87Nm/53ft.lb.

KA-5200AK Max torque: 161Nm/118.7ft.lb.



Extension Wrench

For use with a 1/4" Dr. or 3/8" Dr. ratchet to turn hard to reach nuts and bolts in tight area.

KA-5183A with 1/4" socket, Length: 298mm

KA-5183B with 3/8" socket, Length: 322mm



KA-3753 Star Ring (E-Type) Double Box-End Wrench

- For star ring (E-type) screws.
 - E6 x 8 E10 x 12
 - E14 x 18 E20 x 24
- Bent style
- Wrench matches the special screw conditions.
- Application: E10 x E12 especially for the turbo charger screws on Mercedes-Benz type 211 (E-Class), 203(C-Class) since 2006.



KA-1354 5pcs Hub Nut Kit -VAG / Mercedes Benz

- 1/2" Dr.
- Contents: impact quality M18 x 78mm long spline, E24 star x 38mm long
- Plus: Hex 14mm, 17mm, 19 x 15mmL
- Applications; Volkswagen rear hubs, Mercedes Benz front hubs C class(204) E class(212) Sclass(221)

Re-Chargeable / Data Transmission Digital Torque Wrench



- 999 Memory Record
- Accuracy: $\pm 2\%$
- Display range: 01
- Target Value Setting
- Peak and Trace mode
- 4 unit set: (N-m, lb-ft, lb-in, kg-m)
- Auto Off: 60 seconds (if do not use ratchet)
- 36T quick release
- Battery: AA 1.2V x 2pcs Ni-MH 2300mAh
- USB cable: Micro usb 1.5m (L)
- Storage Temperature / Operating temperature: $-10^{\circ}\text{C} \sim 50^{\circ}\text{C}$ ($14^{\circ}\text{F} \sim 122^{\circ}\text{F}$)
- Operating relative humidity: 15-90%

	KA-1612N	KA-1613N
Drive	1/2"	1/2"
Range	40-200 N-m (29.5~147.6lb-ft)	68-340 N-m (50.1~250.9lb-ft)
Length	530mm	650mm
Weight	1.5kgs	1.5kgs

Pre-Set (adjustable) Digital Torque Wrench



- Accuracy: $\pm 2\%$
- Display range: 01
- Target Value Setting
- Peak and Trace mode
- 4 unit set: (N-m, lb-ft, lb-in, kg-cm)
- Auto Off: 80 seconds (if do not use ratchet)
- 36T quick release
- Battery: AAA x 3pcs
- Storage Temperature: $-20^{\circ}\text{C} \sim 70^{\circ}\text{C}$ ($13.9^{\circ}\text{F} \sim 139.9^{\circ}\text{F}$)
- Operating temperature: $-10^{\circ}\text{C} \sim 60^{\circ}\text{C}$ ($-4^{\circ}\text{F} \sim 157.9^{\circ}\text{F}$)
- Operating relative humidity: 15-90%

	KA-1609C	KA-1612	KA-1613
Drive	3/8"	1/2"	1/2"
Range	27-135 N-m (19.9~99.6lb-ft)	40-200 N-m (29.5~147.6lb-ft)	68-340 N-m (50.1~250.9lb-ft)
Length	460mm	530mm	650mm
Weight	1.2kgs	1.5kgs	1.7kgs

Extended Bar HGV Wheel Nut Wrench



Item No.	Size
KA-5412A-A	25.4mm Φ with 21mm X 41mm X 400mm L(#6140)
KA-5412A-B	25.4mm Φ with 21mm X 38mm X 400mm L(#6140)
KA-5412A-C	25.4mm Φ with 26mm X 33mm X 400mm L(#6140)
KA-5412A-D	25.4mm Φ X 600mmL(S45C)
KA-5412A-E	25.4mm Φ with 17mm X 32mm X 400mm L(#6140)
KA-5412A-F	25.4mm Φ with 17mm X 35mm X 400mm L(#6140)
KA-5412A-G	25.4mm Φ with 17mm X 33mm X 400mm L(#6140)
KA-5412A-H	25.4mm Φ with 19mm X 41mm X 400mm L(#6140)
KA-5412A-I	25.4mm Φ with 20mm X 38mm X 400mm L(#6140)

Extended Bar HGV Wheel Nut Wrench



Item No.	Size
KA-5412B-A	7/8" Φ with 24mm X 27mm X 400mm L(#6140)
KA-5412B-B	25.4mm Φ with 30mm X 32mm X 400mm L(#6140)
KA-5412B-C	25.4mm Φ with 32mm X 33mm X 400mm L (#6140)
KA-5412B-D	19mm Φ X 630mmL (S45C)
KA-5412B-E	25.4mm Φ with 27mm X 30mm X 400mm L (#6140)
KA-5412B-F	25.4mm Φ with 27mm X 32mm X 400mm L (#6140)
KA-5412B-G	25.4mm Φ with 30mm X 33mm X 400mm L (#6140)
KA-5412B-H	25.4mm Φ with 28mm X 33mm X 400mm L (#6140)
KA-5412B-I	25.4mm Φ with 27mm X 33mm X 400mm L (#6140)
KA-5412B-J	25.4mm Φ with 24mm X 38mm X 400mm L (#6140)
KA-5412B-K	25.4mm Φ with 3/4" X 32mm X 400mm L (#6140)

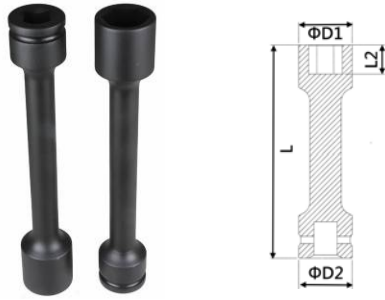

Material: SCM440

3/4"Dr. Extra Long Impact Socket For Wheel Nuts

Item No.	D2 mm	D1 mm	L2 mm	L mm	mm	Nm
KA-2185A	44	43	40	230	13/16"	--
KA-2185B	44	42	40	230	1-1/16"	--
KA-2185C	44	43	40	230	1-1/8"	--
KA-2185D	44	47	40	230	1-1/4"	--
KA-2185E	44	54	40	230	1-1/2"	--
KA-2185F	44	48	40	230	33	--
KA-2185G	44	38.5	24	270	24	--
KA-2185H	44	42	27	270	27	--
KA-2185I	44	45	30	270	30	--
KA-2185J	44	47	32	270	32	--
KA-2185K	44	48	32	270	33	--
KA-2185L	44	53.5	32	270	36	--
KA-2185M	44	38.5	24	400	24	400
KA-2185N	44	42	27	400	27	500
KA-2185O	44	45	30	400	30	550
KA-2185P	44	47	32	400	32	650
KA-2185Q	44	48	32	400	33	650
KA-2185R	44	53.5	32	400	36	650

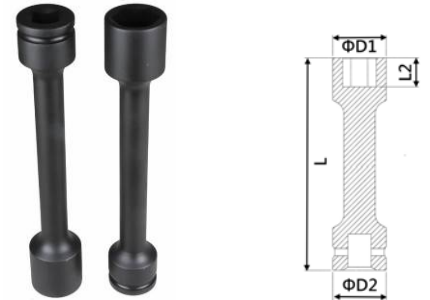

Material: SCM440

1"Dr. Extra Long Impact Socket For Wheel Nuts

Item No.	D2 mm	D1 mm	L2 mm	L mm	mm
KA-2186A	54	51	32	270	1-1/4"
KA-2186B	54	42	24	270	24
KA-2186C	54	44	26	270	26
KA-2186D	54	45	27	270	27
KA-2186E	54	50	30	270	30
KA-2186F	54	52	32	270	32
KA-2186G	54	52	32	270	33
KA-2186H	54	37.5	27	400	23
KA-2186I	54	38.5	30	400	24
KA-2186J	54	41	32	400	26
KA-2186K	54	42.5	32	400	27
KA-2186L	54	45	32	400	29
KA-2186M	54	46	24	400	30
KA-2186N	54	48.5	27	400	32
KA-2186O	54	50	30	400	33
KA-2186P	54	51	32	400	34
KA-2186Q	54	53.5	32	400	36
KA-2186R	54	55	32	400	38



Material: SCM440

1/2"Dr. Metric Universal Extension Impact Socket - 6 Points

Item No.	D2 mm	D1 mm	L2 mm	L mm	mm
KA-2187-10	25	15	9	200	10
KA-2187-11	25	17	9	200	11
KA-2187-12	25	19	11	200	12
KA-2187-13	25	19	11	200	13
KA-2187-14	25	21	11	200	14
KA-2187-15	25	22	11	200	15
KA-2187-16	25	23	11	200	16
KA-2187-17	25	26	13	200	17
KA-2187-18	25	26	13	200	18
KA-2187-19	25	28	13	200	19
KA-2187-21	25	28	13	200	21
KA-2187B	25	28	13	190	1/2"

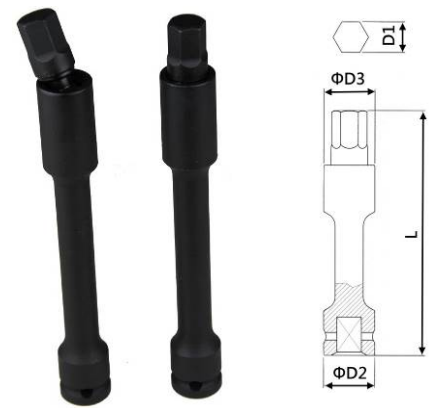

Material: SCM440

1/2"Dr. Long Impact Universal Bit Socket For Internal Hexagonal Screws

Item No.	D2 mm	D1 mm	L mm	D1 mm
KA-2188-10	25	28	200	10
KA-2188-11	25	28	200	11
KA-2188-12	25	28	200	12
KA-2188-13	25	28	200	13
KA-2188-14	25	28	200	14
KA-2188-15	25	28	200	15
KA-2188-16	25	28	200	16
KA-2188-17	25	28	200	17
KA-2188-18	25	28	200	18
KA-2188-19	25	28	200	19
KA-2188-21	25	28	200	21
KA-2188B	25	28	190	1/2"

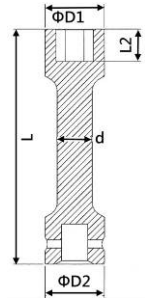

1" Dr. Hexagon Torque Impact Socket, Extra Deep

3/4"Dr. Hexagon Torque Impact Socket, Extra Deep

Item No.	L (mm)	Size	Torque N.m
KA-2189A	300	■ 13/16"	650
KA-2189B	300	● 1-1/4"	340
KA-2189C	300	● 33mm	600
KA-2189D	300	● 1-5/16"	650
KA-2189E	300	● 30mm	450
KA-2189F	300	● 1-1/2"	650
KA-2189G	300	● 24mm	350
KA-2189H	300	● 27mm	350
KA-2189I	300	● 27mm	450
KA-2189J	300	● 29mm	400
KA-2189K	300	● 30mm	350
KA-2189L	300	● 30mm	500
KA-2189M	300	● 30mm	550
KA-2189N	300	● 32mm	450
KA-2189O	300	● 32mm	500
KA-2189P	300	● 32mm	550
KA-2189Q	300	● 32mm	600
KA-2189R	300	● 32mm	650
KA-2189S	300	● 32mm	700
KA-2189T	300	● 32mm	750
KA-2189U	300	● 33mm	550
KA-2189V	300	● 33mm	650
KA-2189W	300	● 33mm	700
KA-2189X	300	● 33mm	750
KA-2189Y	300	● 36mm	600

Item No.	D1 mm	D2 mm	L2 mm	d mm	L mm	Size	Torque N.m
KA-2190A	49.2	42	30	23	305	■13/16"	650
KA-2190B	46.7	42	30	18	305	●1-1/4"	340
KA-2190C	54	42	30	23	305	●1-5/16"	650
KA-2190D	58	42	30	22	305	●1-1/2"	650

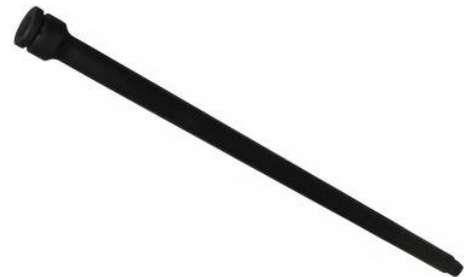

KA-2184 1" Drive Impact Extension Bar

- With 1" square drive.
- Special size to L/1M.
- Chrome molybdenum.

L (cm)	□
81	1"



**KA-3479-BM21
21pcs 1/4" Super Short Bits Set
(Injection Case)**

16mm Dr. bit: PH2- PH3- PZ2- PZ3- SL3- SL4- SL5- SL6- H3- H5- H6- T8- T10- T15- T20- T25- T27- T30- T40

**KA-3479-SM12
12pcs 1/4" Super Short Bits
Set (Injection Case)**

Size: 4-4.5-5-5.5-6-7-8-9-10-11-12mm

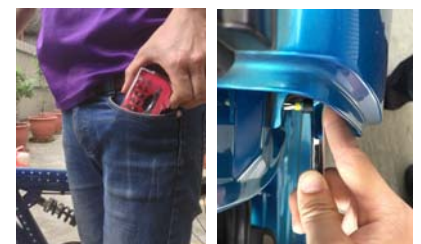

Lockable Quick Oil-Tube Wrench

- With quick function in open side.
- Continue work to save time in oil-tube repair.
- Support 5 different angle in open side.
- Mirror Finish / Mirror Satin Finish
- All drop forged from chrome vanadium steel (CR-V) AISI6140.
- Patented.

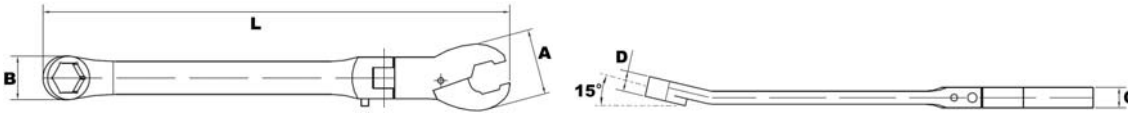
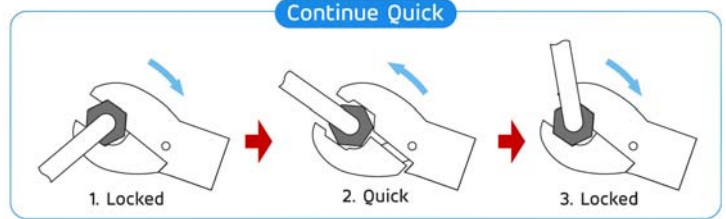

Item No.	Size (mm)	L	A	B	C	D	G
KA-2193-10	10	175	20	15.12	7.87	9.12	105.
KA-2193-11	11	182	22	16.40	8.10	9.85	117
KA-2193-12	12	190	24	17.75	8.34	10.62	130
KA-2193-13	13	200	26	19.47	8.75	10.87	145
KA-2193-14	14	210	28	21.20	9.15	11.05	160
KA-2193-15	15	220	29	22.72	9.65	12.25	177
KA-2193-16	16	230	30	24.25	10.20	13.30	195
KA-2193-17	17	241	32	25.11	10.60	13.80	215
KA-2193-18	18	253	34	26.00	10.90	14.30	234
KA-2193-19	19	265	35	26.85	12.00	14.80	255

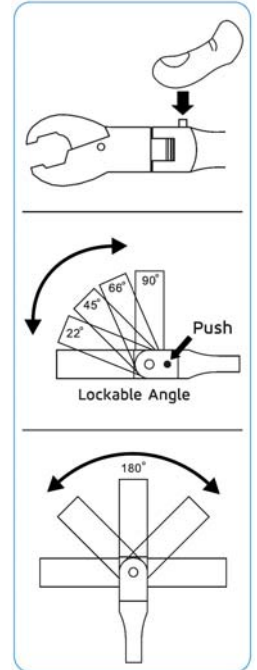

LS Type Bolt-Extractor Combination Wrench

- Support normal screw use.
- Take out stripped screw.
- Anti-obstruction.
- Patented
- Mirror Finish / Mirror Satin Finish
- All drop forged from chrome molybdenum steel (CR-MO) SCM440

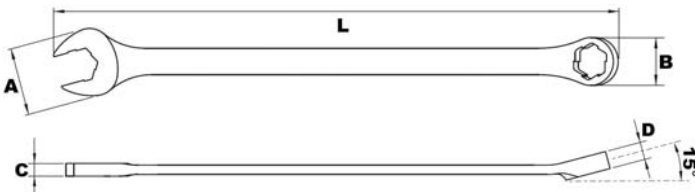

	Size (Metric)	Size(SAE)	L	A	B	C	D	G
KA-2194-8	8	5/16"	168	20.0	13.3	5.3	6.0	40.0
KA-2194-9	9	3/8"	178	21.0	14.6	6.0	6.4	50.0
KA-2194-10	10	--	188	22.8	16.4	6.3	6.9	60.0
KA-2194-11	11	7/16"	207	24.6	17.3	6.4	7.0	65.0
KA-2194-12	12	--	220	27.2	18.8	6.4	7.8	85.0
KA-2194-13	13	1/2"	242	28.6	20.9	6.7	8.5	110.0
KA-2194-14	14	9/16"	260	31.4	22.2	7.1	9.1	140.0
KA-2194-15	15	--	278	33.5	23.4	7.1	9.3	155.0
KA-2194-16	16	5/8"	292	35.3	24.9	7.6	10.0	175.0
KA-2194-17	17	11/16"	313	37.6	26.7	8.4	11.0	215.0
KA-2194-18	18	--	332	39.4	27.5	8.0	11.3	235.0
KA-2194-19	19	3/4"	349	41.5	29.4	8.7	12.7	270.0

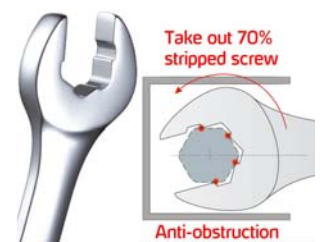



Extendable Ratched Handle With Flexible Head (72 Teeth)

- Reversible head for versatility
- Strong torque for heavy duty work.
- With 72 tooth and Quick release for labor and time saving.
- Extendable handle with comfort grip rubber



Item No.	Drive	Extend Length
KT-14FR KT-14LFR (locking type)	1/4"	175mm to 225mm
KT-38FR KT-38LFR (locking type)	3/8"	250mm to 350mm
KT-12FR KT-12LFR (locking type)	1/2"	350mm to 490mm

KA-RH1634-4114

1/4" Affordable Digital Torque Wrench Tool set

Contents:

HBS: 1/4" :H2, H5, H3, H4, H5, H6, H7, H8, H10, PH2, T25, T30
 Adapter : 1/4" * 4" / 1/4" (Femal) * 3/8"



Accuracy	+/-3%
Torque Range	6-30Nm(4.4-22.1lb-ft)
Resolution	0.1Nm (0.1lb-ft)
Preset	1
Memory	50
Torque Unit	4(Nm. Lb-ft. Lb-in,kg-cm)
Mode	Trace / Peak
Alert	LED & Buzzer
Battery	2pcs * AAA
Length	200mm
Auto shout off	70seconds
Operating ambient temperature	-10°C-60 °C °F-139.9 °F)
Storage temperature	-20 °C -70 °C (-4 °F-57.9 °F)
Operating relative humidity	15-90% noncondensing

1/4" Mini Digital Torque Wrench Tool

Preset frequently used torque reading on the mini digital torque wrench. It doesn't need unwind spring like mechanical design, when reset a new torque reading.



- 1/4"Dr. 72T
- Accuracy +/-3%
- Digital torque value reading
- Target torque value setting
- 1 memory record
- Track and Peak hold mode
- Alarm: LED light bar and buzzer
- Powered by 1 x AAA batteries
- 4 unit set (Kg-cm, lb-in, lb-ft, cNm)
- Auto shut off: 60 seconds (if do not use digital torque adapter)
- Length: 212mm
- Weight: 0.23kgs

	KA-1633M-50	KA-1633M-250	KA-1633M-500	KA-1633M-1000
Accuracy	+/-4%	+/-3%	+/-3%	+/-3%
Pre-set	10 sets			
Torque Range	0.5~50cNm	2.5~250cNm	50~500cNm(0.5~5Nm)	100~1000cNm(0.1~10Nm)
Display Resolution	0.1cNm /0.01lb-in, 0.01kgs-cm			
Operating ambient temperature	0°C-50 °C (32°F-122 °F)			
Storage temperature	-10 °C -60 °C (-13.9 °F-139.9°F)			
Operating relative humidity	5-90% noncondensing			



Digital Torque Wrench with Angle Function

No more "flash" display of "torque then angle".
 "Simultaneous" display of torque and angle.

- Torque and Angle provide the most accurate and fast way to achieve torque plus angle.
- The angle reading measured can be accumulated when used in limited space.
- It can measure angle directly, do not need mechanical angle gauge.

Torque Accuracy	C.W: 2% / C.C.W: 2.5% (+/-1% of reading) + (+/- 1% angular velocity>10%<180%)
Angle Accuracy	
Angle Range	0-360°
Torque / Angle Reading Display	Simultaneous/Flashing
Torque Range	27-135Nm (19.9-99.6lb-ft)
Resolution	0.1Nm (0.1lb-ft)
Length	465mm
Weight	1.4kgs
Backlight	Yes (negative)
Resolution	0.1Nm (0.1lb-ft)
Torque Preset	10
Angle Preset	1
Memory(Torque Reading) / Angle	100(10 memory for each preset) / 50
Unit	Nm. Lb-ft. In-ft. Kg-m
Mode	Trace / Peak
Alert	L.E.D & Buzzer
Battery	3pcs * AAA
Auto shut off	60 seconds
Operating Ambient Temperature	-10°C-60°C (-2°F-139.9°F)
Storage Temperature	-20°C-70°C (-4°F-57.9°F)
Operating Relative Humidity	15-90% noncondensing

	KA-1600-83	KA-1600-21A	KA-1600-21B
Dr. / Teeth	3/8" / 72T	1/2" / 36T	1/2" / 36T
Torque Range	27-135Nm (19.9-99.6lb-ft)	40-200Nm (29.5-147.6lb-ft)	68-340Nm (50.1-250.9lb-ft)
Length	465mm	530mm	650mm
Weight	1.4kgs	1.5kgs	1.6kgs

KA-2201 Metric Socket / Wrench Insert Set (No-Marring)

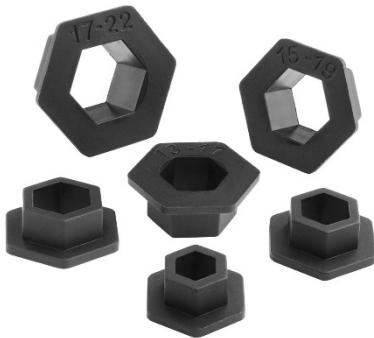

- Ideal for classic and high quality vehicles.
- Sizes 12mm reduced to 8mm, 14 reduced to 10mm, 16mm reduced to 12mm, 17 reduced to 13mm, 19mm reduced to 15mm, 22mm reduced to 17mm.
- Prevents damage to Chrome and anodised bolts (Non marking).

Fastener	Socket	Torque
8 mm	12 mm	9 Nm
10 mm	14 mm	17 Nm
12 mm	16 mm	27 Nm
13 mm	17 mm	45 Nm
15 mm	19 mm	50 Nm
17 mm	22 mm	79 Nm



KA-9074 Adjustable Tap Socket

- Designed for use with taps, reamers, screw extractors and other tools with a square shank.
- 3/8" Dr. x 19mm
- Two sections design fits common taps from M4~M14.
- Fits all 3/8" square drive tools.
- For use in tight workspaces.

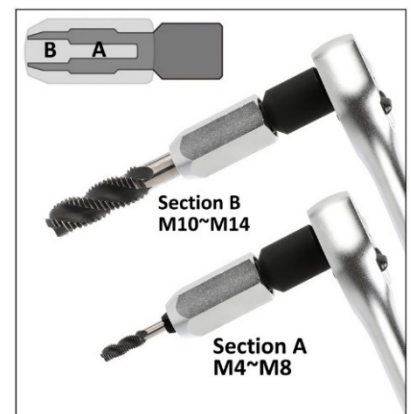
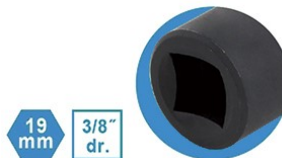



KA-4530
1/4" Dr. Crowfoot Wrench Set

- Used in hard to reach, confined spaces.
- Adapted to low torque applications.
- Including 1/4" Dr. breaker bar, 1/4" extension bar.
- Sizes: 7, 8, 10, 11, 12, 13, 14mm.



KA-3336KN Aluminum AN wrench set

- Size included are -6, -8, -10, -12, and -16.
- Each wrench is finished in different color anodizing for effortless to discern.
- Five piece, aluminum wrench set for make use of aluminum AN-style, braided hose fittings manufactured by Aeroquip.



KT-7718-15 Torque Tester

- Specialized torque testing equipment designed for the variety of mechanical torque wrenches.
- Simple, accurate and cost-effective torque tester for performing calibration checks in house.
- High speed of data reading performance (2400 run/sec.)
- RC-232 communication port is included for the output of reading to PC.
- There are six torque units available for application (Lb-ft, Lb-in, N-m, N-cm, kg-m, kg-cm).
- As standard, the transducer is calibrated in a clockwise direction with a traceable calibration certificate.
- Quality meets BS7882:1997 standard with the accuracy of +/- 0.5% of reading over the 20%~100% of full scale.
- With three operating modes: "Track" displays the live value, "Peak" records the highest value and "First Peak" records the first peak of torque.
- Under "First Peak" mode, the "light signal" and "Buzzer" indicate the testing completion and testing return to zero.
- Memory function can display the 4 previous readings taken by the operator. It's no need to stop and write after each reading.

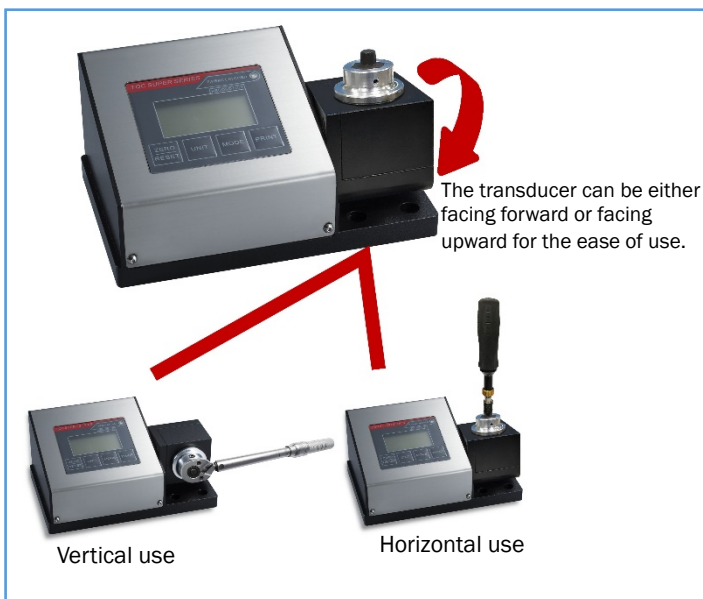

Calibration Range (N-m)	0.75~15Nm
Accuracy	±0.5%
Units of Measurement	Lb-in, lb-ft, kg-cm, N-m, N-cm
System Resolution (N-m)	0.001
Input Hex A/F (mm)	10mm
Square Drive Adaptor (inch)	1/4" , 3/8"
Operating Temperature Range	+5°C~ +40°C
Storage Temperature Range	+0°C~ +70°C
Power Cable	200mm
Power Consumption (watt)	5
Dc Power Output	DC9.0V
Base Materials / Finish	Aluminum / Painting
Dimensions (L*W*H)	237*150*106mm
Weight	7.7kg

Magnetic Socket Inserts

- Magnetic insert holds the fastener/nut/screw firmly within the socket.
- Magnetic insert can be installed/removed from the socket easily.

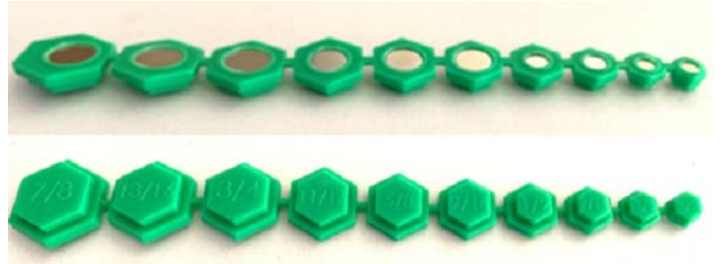
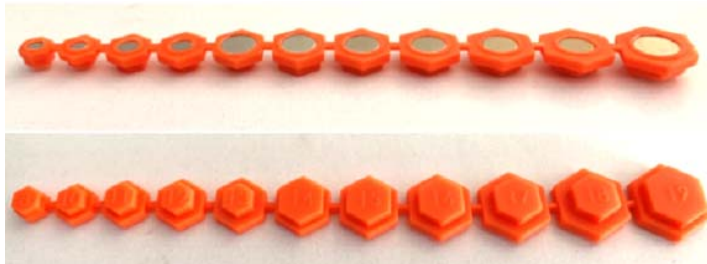

KA-2201A 11 PCS/SET

- For Metric Sockets.
- Size: 8, 10, 11, 12, 13, 14, 15, 16, 17, 18, 19mm

KA-2201B 10 PCS/SET

- For SAE (Inch) Sockets.
- Size: 5/16", 3/8", 7/16", 1/2", 9/16", 5/8", 11/16", 3/4", 13/16", 7/8"



Put nut or screw over the Magnetic Insert



Inserts linked by plastic strip

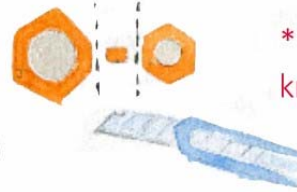

* Be careful in using knife!

Separate the inserts with Utility Knife



KA-6393I Flexible Crows Foot Wrench 22mm 3/8"DR 6PT

- Suitable for exhaust gas sensors on many modern vehicles.
- 3/8"Dr. 6 point 22mm (7/8") Hex profile



KA-5098 Two-Function Socket & Bit Adapter Tool

- 200mm L
- For 3/8"Dr. Socket & 1/4" Hex Bit

KA-5098A Two-Function Socket & Bit Adapter Tool

- 200mm L
- For 1/2"Dr. Socket & 1/4" Hex Bit



360 Degree



360 Degree

* Material:
Body: Aluminum (anodizing Blue)
End Tips: 6150 Manganese Phosphate

Breakback Torque Wrench – Industrial Grade !!

Item No.: KA-4533-1F / KA-4533-2F / KA-4533-3F
 KA-4533-1FN / KA-4533-2FN / KA-4533-3FN



- ➔ For HGV / Heavy Duty Vehicles
- ➔ Unique “Breakback” action prevent the “over-torque”

- An Unique Breakback (Break Point) action/signal of profiled cam plate and reaction plate, providing a clearer torque break point.
- Excellent for using in “Noisy” environment, where the operator would likely to miss the click sound when reaching the desired torque. But with Breakback Torque Wrench, it would give operator a clear visual of breakback (break point) action.
- The Breakback (Break Point) action can not only be seen by the user, but also the supervisor or onlooker.



Specification:

Item No.	Square Drive	Teeth	Nm/ft-lb	Graduation	Weight (g)	Length (mm)
KA-4533-1F	3/4"	36T	120-600 / 100-450	10	6600	1060
KA-4533-2F	3/4"	36T	200-800 / 150-600	10	7900	1320
KA-4533-3F	3/4"	36T	300-1000 / 200-750	20	8060	1550
KA-4533-1FN	1"	36T	120-600 / 100-450	10	6600	1060
KA-4533-2FN	1"	36T	200-800 / 150-600	10	7900	1320
KA-4533-3FN	1"	36T	300-1000 / 200-750	20	8060	1550

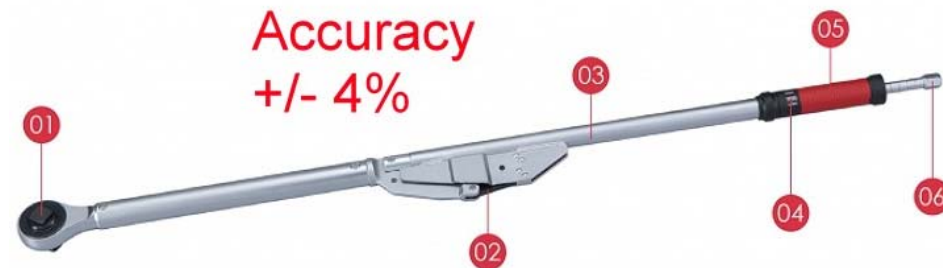

- ① **Round head:**
A highly robust ratchet mechanism with inner 4 pawls mechanism design to bear large output value, without plate and screws to avoid losing while operation. Push-through square drive
- ② **Reliable mechanism:**
The unique linking plate and support plate design gives very clear "torque break point", which reduces the possibility of over torquing, even in arduous working conditions.
- ③ **Serial number:** Each piece stamping serial number for track the production
- ④ **Scales:** Window Screen. Dual scale. Easy readable for two different units.
- ⑤ **NBR handle:** Ergonomic shape with non-slip and comfortable features.
- ⑥ **Adjustment system:** Apply revolving handle to turn nut for torque adjustment



The cam plate and reaction plate signal a “brake point” when reach the torque.

A great signal that can be spot by operator and supervisor.

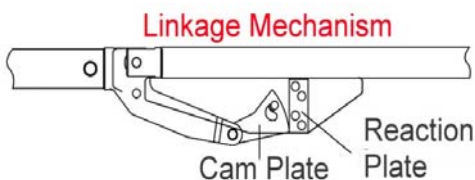
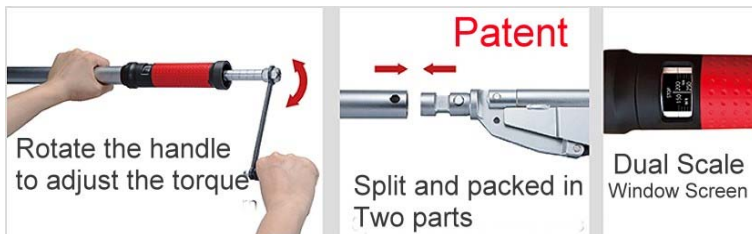

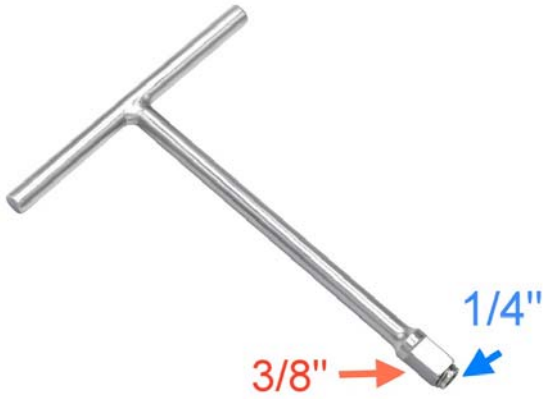

KA-5088BT Two-Way T-Wrench with Adaptor for 3/8" Socket & 1/4" Bit

→ T-Handle with shank for assembled with bit or socket

Diameter: 10mm
CRV Handle: 120mm
CRV Shank: 150mm



KA-5088BTK



KA-5088BTK1



KA-5088BTK2

	KA-5088BTK	KA-5088BTK1	KA-5088BTK2
KA-5088BT	●	●	●
3/8" Dr. Socket - CRV	8, 10, 12, 13, 14	8, 10, 12, 13, 14	8, 10, 12, 13, 14
1/4" 25mmL Bit - S2	1/4", PH2, PH3, SL4, SL5, SL6, H2, H3, H4, T10, T15, T20	PH2, PH3, SL4, SL5, SL6, H2, H3, H4, T10, T15, T20	1/4", PH2, PH3, SL4, SL5, SL6, H2, H3, H4, T10, T15, T20
1pc Tire Valve	X	●	●



KA-5088FL Two-Way T-Wrench with Adaptor for 3/8" Socket & 1/4" Bit

→ Foldable Handle with shank for assembled with bit or socket

Diameter: 10mm
Nylon Handle: 85mm
CRV Shank: 150mm



KA-5088FLK



KA-5088FLK1



KA-5088FLK2

	KA-5088FLK	KA-5088FLK1	KA-5088FLK2
KA-5088FL	●	●	●
3/8" Dr. Socket - CRV	8, 10, 12, 13, 14	8, 10, 12, 13, 14	8, 10, 12, 13, 14
1/4" 25mmL Bit - S2	1/4", PH2, PH3, SL4, SL5, SL6, H2, H3, H4, T10, T15, T20	PH2, PH3, SL4, SL5, SL6, H2, H3, H4, T10, T15, T20	1/4", PH2, PH3, SL4, SL5, SL6, H2, H3, H4, T10, T15, T20
1pc Tire Valve	X	●	●

Patented in Taiwan, U.S.A., Germany & China

- Specially design to quickly fasten or loosen long fasteners in hard-to-reach places.
- The sliding aluminum collar with knurled handle can be locked in **3 positions**.
- Adjustable T-handle Driver rotate the fasteners quickly and continuously with free spinning collar mechanism.
- Achieving higher Torque.



KA-5099-BIT HOLDER
1/4" Bit Holder

KA-5099-H38

KA-5099-H12

Sliding-Collar T-Handle Tool
Swivel, Quick

KA-5099-Bit Holder

- 1/4" Hex Bit Holder Driver
- D10*140*311mm
- Magnet:NdfeB D6*2mm



KA-5099-H14

1/4" Driver D10*140*311mm

KA-5099-H38

3/8" Driver D10*180*311mm

KA-5099-H12

1/2" Driver D10*240*311mm



KA-5099
Double-End Square-Head Quick / T-Handle Driver

Grip

- Rubber Coated
- Ø22*100mm

T-Handle

- Aluminum (knurled + milled), anodized, Chrome Plated.
- Length

Short Pole: Ø10*170mm

Long Pole: Ø10*311mm

Sliding Collar

- Aluminum, Knurled



**KA-5099K
Universal Go-Through Ratchet & Quick Swivel T-Handle Set**

- Tornado Rotation Mechanism

- The universal Go-Through Ratchet can be Converted to Quick-Swivel T-Handle
- 360° Rotation / Tornado force mechanism saves time and labor.
- Regardless the protruding thread length through the nuts.
- Suitable for any application and space, Easy to Use.

Content:

1pc	1/4" Universal Go-Through Ratchet 165mL
1pc	Quick Swivel T-handle H13 x 120mmL
11pcs	1/4" (H:13mm) Go Through Socket:
1pc	1/4" Dr x 13mm Quick Release Adaptor
1pc	1/4" Dr x 13mm Bit Adaptor
1pc	M13mm x H13mm Hex Adaptor
1pc	1/4" x 1/4" Bit Adaptor
18pcs	18pcs 1/4" Hex Bit Set Slotted: SL4, SL5, SL6 Phillips: PH1, PH2, PH3 Pozidriv: PZ1, PZ2, PZ3 Hex: H3, H4, H5, H6 Torx: T10, T15, T20, T25, T30

When T-bar in inserted to the Go-Through Ratchet, the T-bar becomes a handle.

➔ Grip on the blue sleeve, the turn the t-bar with force, the t-bar turn with continuous rotation force to make loosening/tightening effortlessly like following:

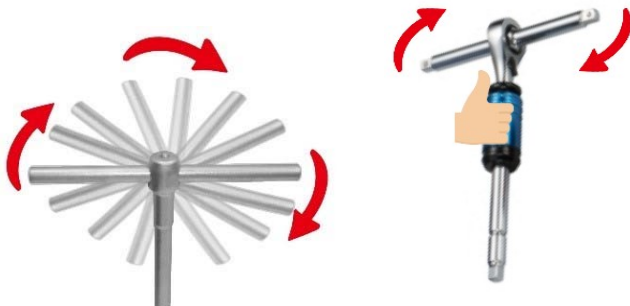

This kit is multi-functional, great to overcome following situation:

Situation 1: Working space is too confined and in low-height.



✘ The Regular Ratchet Handle + Socket is too tall to loose/tighten the bolt

○ Use KA-5099K Go-Through Handle + Socket is right height to loose/tighten the bolt.

Regular Ratchet Handle + Socket



>

Go-Through Ratchet + Socket



Situation 2: Working space is too narrow and deep.



✘ The Regular Ratchet Handle + Socket can't reach deep space, The T-Shape Socket Wrench is too large to work in narrow space.

○ Use KA-5099K Go-Through Handle + Rotating T-Bar + Socket is thin and long enough to work in narrow confined place.

Regular Ratchet Handle + Socket



>

Go-Through Ratchet + Socket

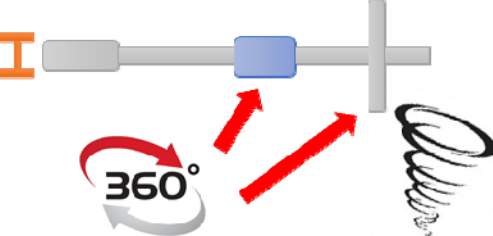



Quick Release Reversible Curved Ratchet Handle



KT-QR1436
KT-QR3648
KT-QR1272
Series



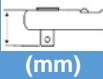
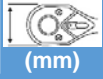

KT-QR1436B
KT-QR1448B
KT-QR1472B
Series

36T	48T	72T	Size	L(mm)	 (mm)	 (mm)	 g	ANSI (N.M)	DIN (N.M)
KT-QR1436	KT-QR1448	KT-QR1472	1/4"Dr.	145	25	26.5	130	51	62
KT-QR3836	KT-QR3484	KT-QR3872	3/8"Dr.	200	33	32	288	204	202
KT-QR1236	KT-QR1248	KT-QR1272	1/2"Dr.	255	40	57040	570	509	512
KT-QR1436B	KT-QR1448B	KT-QR1472B	1/4"Dr.	145	25	27.8	134	51	62
KT-QR3836B	KT-QR3484B	KT-QR3872B	3/8"Dr.	205	33	31.5	296	204	202
KT-QR1236B	KT-QR1248B	KT-QR1272B	1/2"Dr.	255	40	40	584	509	512



*** Anti-Oil Grip * Ratchet Handle**

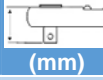
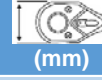

Oil-Resistant, Anti-Corrosion, Durable

Item No.	Size	L(mm)	 (mm)	 (mm)	 g	ANSI (N.M)	DIN (N.M)
KT-14AOG	1/4"Dr.	157	13	26	146	51	62
KT-38AOG	3/8"Dr.	201	17.6	32.5	298	204	202
KT-12AOG	1/2"Dr.	258	20.6	41	544	509	512

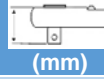
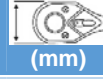

*** Anti-Oil Grip * Ratchet Handle**

Oil-Resistant, Anti-Corrosion, Durable

Item No.	Size	L(mm)	 (mm)	 (mm)	 g	ANSI (N.M)	DIN (N.M)
KT-14AOGL	1/4"Dr.	160	13	26	146	51	62
KT-38AOGL	3/8"Dr.	201	17.6	32.5	312	204	202
KT-12AOGL	1/2"Dr.	256	20.6	40	548	509	512





KT-1472TLR / KT-3872TLR /
KT1272TLR



KT-1472TLA / T-3872TLA /
KT1272TLA

72T Leopard Ratchet Handle

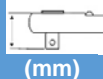
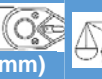
*** Thin Profile ***

Item No.	Size	L(mm)	 (mm)	 (mm)	 g	ANSI (N.M)	DIN (N.M)
KT-1472TLR	1/4"	138	18	25	86	51	62
KT-1472TLA	1/4"	138	18	25	86	51	62
KT-3872TLR	3/8"	192	26	31	204	204	202
KT-3872TLA	3/8"	192	26	31	204	204	202
KT-1272TLR	1/2"	260	34	39	442	509	512
KT-1272TLA	1/2"	260	34	39	442	509	512

108T Ratchet Handle - Ergonomic Design





KT-14108RH
KT-38108RH
KT-12108RH



KT-14108RH2
KT-38108RH2
KT-12108RH2



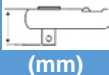

KT-14108RHA
KT-38108RHA
KT-12108RHA

Item No.	Size	L(mm)	 (mm)	 (mm)	 g	ANSI (N.M)	DIN (N.M)
KT-14108RH	1/4"	133	18	22	78	51	62
KT-14108RH2	1/4"	133	18	22	78	51	62
KT-14108RHA	1/4"	133	18	26	215	51	62
KT-38108RH	3/8"	192	26	28	206	204	202
KT-38108RH2	3/8"	192	26	28	220	204	202
KT-38108RHA	3/8"	192	26	32	513	204	202
KT-12108RH	1/2"	260	34	36	472	509	512
KT-12108RH2	1/2"	260	34	36	478	509	512
KT-12108RHA	1/2"	260	34	40	1061	509	512



Giraffe Ratchet Handle

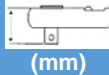

*Flex Head Extra Long
Extra Long, Flex Head, Locking.

Item No.	Size	L(mm)	 (mm)	 (mm)	 g	ANSI (N.M)	DIN (N.M)
KT-1412XLF	1/4"Dr.	285	25	27	260	51	62
KT-3818XLF	3/8"Dr.	450	33	32	704	204	202
KT-1224XLF	1/2"Dr.	610	42	42	1348	509	512

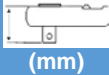

Cobra Ratchet Handle

* Extra Long Neck
Extra Long, Locking

Item No.	Size	L(mm)	 (mm)	 (mm)	 g	ANSI (N.M)	DIN (N.M)
KT-1412CXL	1/4"Dr.	285	25	27	270	51	62
KT-3818CXL	3/8"Dr.	450	33	32	428	204	202
KT-1224CXL	1/2"Dr.	610	42	42	593	509	512

Multi-Range Preset Torque Wrench – Industrial Standard

Quality meets DIN ISO 6789 & ASME B107.300-2010



Features

1. Industrial application with durability.
2. CW/CCW directions.
3. Quick release button design.
4. Torque value can be preset from 85, 103, 108 to 138Nm; we offer 2, 3 or 4 stage options!
5. The knurled metal handle brings the non-slip profit.
6. Easy torque setting with external scale and knob.
7. Lock function is designed to get rid of the possible misuse.
8. Tolerance of torque +-3%.

Specification

1. Ratchet head: A highly robust ratchet mechanism for CW and CCW directions application. Quick released design for changing socket quickly. Repair kit for inner spare parts of ratchet head is available.
2. Reliable mechanism: The robust and resistant fully chromed steel tube is ideal of industrial use. An audible and palpable signal indicates automatically when the desire torque value is achieved.
3. Metal Handle: The fine knurled metal handle to against oil, dust and slip issue for even long time use.
4. Adjustment Knob: There are 2 to 4 stage options in preset value from 85,103,108 to 138Nm.
-> New Type is 5 stage from 80,100,120,140 to 160.
-> Turn the knob to indicated preset value, then turn switch CW direction to lock.

Item No.	Square Drive	Teeth	Torque Range	Weight (g)	Length(mm)
KA-4536-1D	1/2"	32T	103/108 Nm	1240	462
KA-4536-2D	1/2"	32T	85/103/108 Nm	1240	462
KA-4536-3D	1/2"	32T	85/103/108/138 Nm	1240	462
KA-4536-3D1	1/2"	32T	85/103/108/120 Nm	1240	462
KA-4536-4E	1/2"	32T	80/100/120/140/160 Ft-lbs	1240	462